

HY-CDSSU Series

Dedicated Power Supply For Capacitor Charging And Discharging

Hangyu Power System (Shanghai) Co., Ltd



HY-CDSSU Series Dedicated Power Supply For Capacitor Charging And Discharging



Application Field

HY-CDSSU series capacitor charging and discharging specialized equipment is applied to capacitor manufacturers, capacitor users, and capacitor testing and measurement units, and can perform dv/dt testing.

The method is to first charge the tested capacitor and measure the dv/dt value during the rapid discharge process of the capacitor. The signal voltage, frequency, and discharge resistance can be set as needed. The signal is applied to both ends of the tested capacitor, the test cycle is set, and the capacitor is continuously tested. During the test, the temperature rise, capacity, and loss of the capacitor are continuously monitored and recorded. Finally, evaluate whether the capacitor meets the requirements based on its temperature rise and changes in capacity and loss.

By using this method for detection, whether it is the characteristics of the material (polarization characteristics), different structural designs (electrode resistance), or differences in losses, they can be intuitively reflected through the temperature rise and capacity loss changes of the capacitor.



Product Features

HY-CDSSU series capacitor charging and discharging special equipment is a programmable constant voltage and current source, which is dedicated to dv/dt, charging and discharging related tests. The specific parameters are as follows:

- Input voltage: 220VAC50HZ
- Output voltage: 0-2000Vrms Continuously adjustable (customizable)
- Output capacity: 200VA-10kVA
- Charging and discharging test current: 0-3000A (customizable)
- It is necessary to detect the actual voltage on the tested product and display it (at a frequency of 1kHz, take the average value of the charging voltage every 10 times and display it; the trigger time of the machine is about 300mS) to determine whether the product is fully charged; If there is no voltage, output an alarm signal
- Trigger mode can be switched between manual and automatic modes; How long should it be triggered and how long should the device work continuously
- Charging and discharging frequency: 0.5k/1kHz (customizable)
- Discharge resistance: 0Ω
- Test capacitor capacity: 1nF~110uF (customizable)
- Multiple protection functions: OVP/OCP/OTP
- 19 inch standard rack size
- Touch screen operation&numeric keypad input
- Multi stage shuttle adjustment knob
- The power input is controlled by a circuit breaker, which is safer
- Output ON/OFF button
- Intelligent speed control design for fans, reducing noise
- Supports Modbus protocol
- Standard interface: RS-485&RS-232
- Purchase interface: LAN、CAN、GPIB、USB、Analog programming and monitoring (isolated type)

Selection Guide

Product Model Naming Rules

Product Series	Output voltage	Output current	Optional function
HY-CDSSU	400	- 1650	- CF

Model: HY-CDSSU 10-40-CF
 The model information is: output voltage 0-400V,
 output current 0-1650A
 Choose user defined features

HY-CDSSU Series Selection

Models	Output voltage	Output current
HY-CDSSU 400-1650	400V	1650A
HY-CDSSU 1000-600	1000V	600A
HY-CDSSU 1000-1000	1000V	1000A
HY-CDSSU 1200-1500	1200V	1500A
HY-CDSSU 2000-1500	2000V	1500A

In the selection table, special specifications beyond the voltage/current/power range are accepted for customization

Measured On-Site

Measure with this device with a maximum voltage of 1000V and a maximum current of 1000A, and connect both ends of the thin film capacitor.

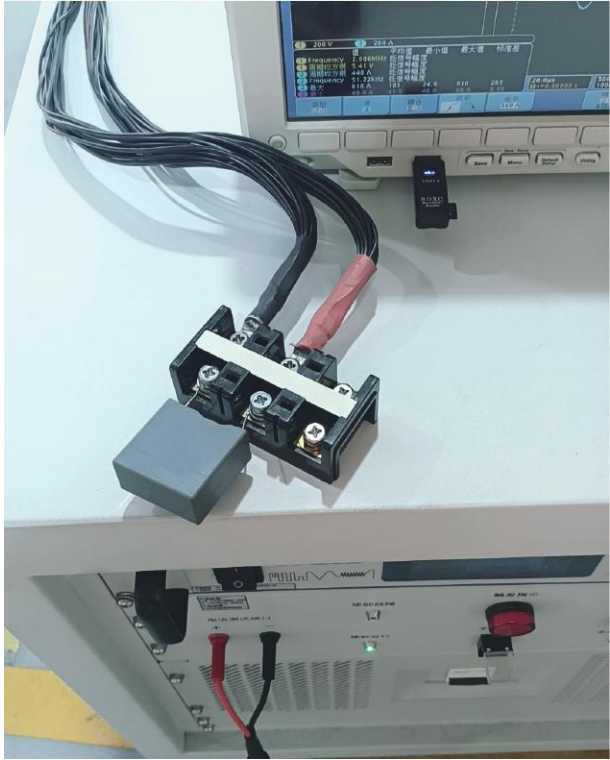

HY-CDSSU Series Technical Parameter

The following is the measured waveform diagram:

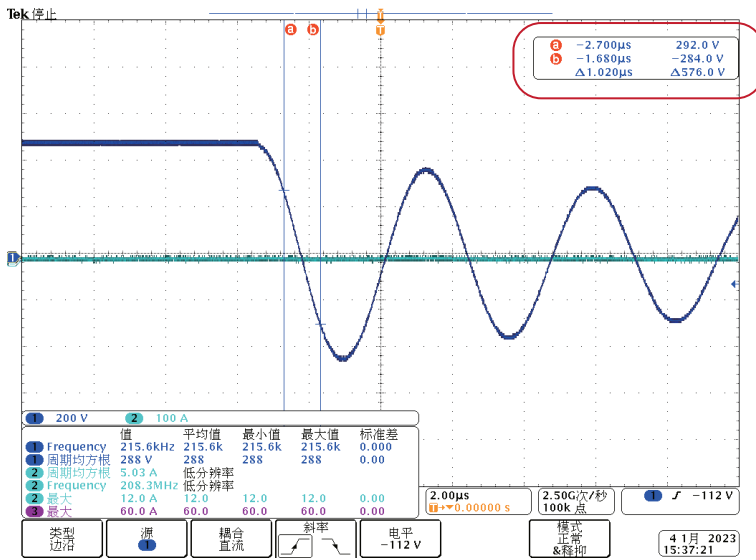

Voltage Drop Time

The measured waveform of voltage dv/dt is shown in the figure above, Charge the tested capacitor first, Further rapid discharge, Voltage drop speed $< 10 \mu S$, Other parameters are shown in the figure.

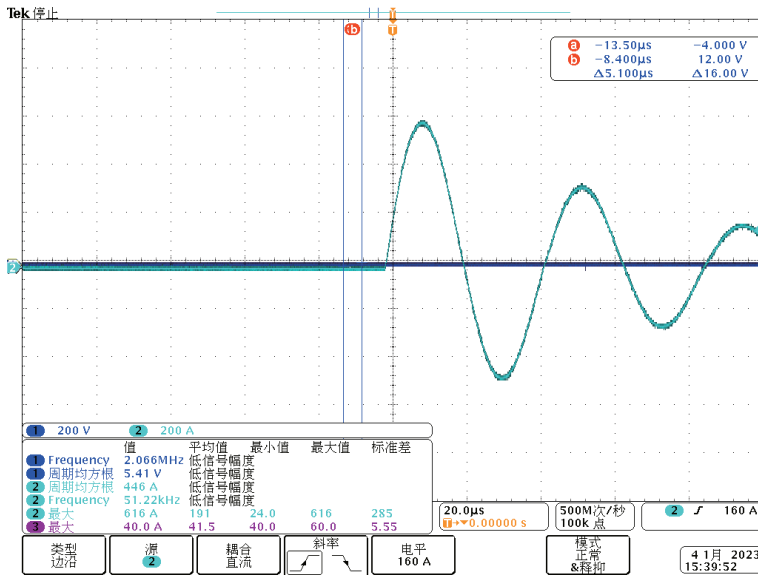

The measured waveform of current charging and discharging is shown in the left figure

Charging and discharging test of Hangyu power capacitor Dedicated solution to meet capacitor dv/dt Testing requirements, intelligent and convenient operation, high efficiency, Greatly saving testing costs and improving capacitor quality To enhance and escort.

Appearance And Display

10U 440(W)*600(D)*445(H)mm

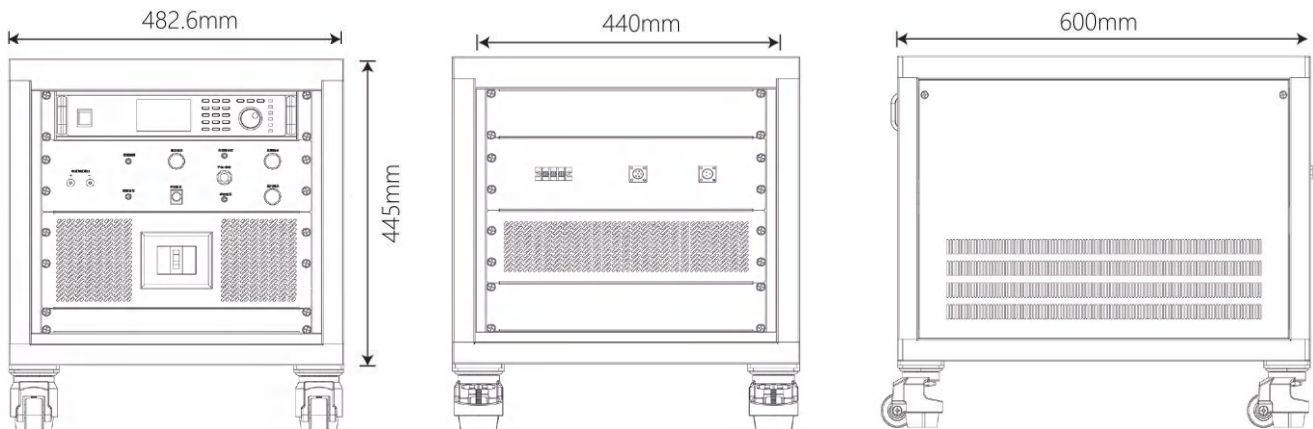

Cooperative Customers (Part)

Aerospace & Defense Military Research Institute



China Aerospace



Aerospace science and engineering



Aviation industry



China Air Development



China Electrical Engineering Group



China Shipbuilding Corporation



China Shipbuilding Industry Corporation

CASC 803 (Shanghai Aerospace Control Technology Institute)
 CASC 800 (Shanghai Aerospace Precision Machinery Research Institute)
 CASC 804 (Shanghai Aerospace Electronic Communication Equipment Research Institute)
 CASC 805 (Shanghai Aerospace System Engineering Institute)
 CASC 808 (Shanghai Precision Measurement and Testing Institute)
 CASC 811 (Shanghai Space Power Research Institute)
 CASC 812 (Shanghai Satellite Equipment Research Institute)
 CASC 801 (Shanghai Space Propulsion Research Institute)
 CASC 502 (Beijing Control Engineering Research Institute)
 CASC 510 (Lanzhou Institute of Space Technology Physics)
 CASIC 206 (Beijing Machinery and Equipment Research Institute)
 CASIC 304 Institute (Beijing Great Wall Institute of Measurement and Testing Technology)
 CASIC 307 Factory (Aerospace Chenguang Co., LTD.)
 33 CASIC (33 Aerospace Science and Industry Institutes)
 CASIC 3651 Factory (Guizhou Aerospace Linquan Motor Co., LTD.)
 AVIC 615 (Aeronautical Radio Electronics Research Institute of China)
 AVIC 618 (Xi'an Flight Automatic Control Research Institute)
 AVIC 105 Factory (Tianjin Aviation Electromechanical Co., LTD.)
 AVIC 115 Factory (Shaanxi Aero Electric Co., LTD.)

AVIC 118 Factory (Shanghai Aviation Electric Appliance Co., LTD.)
 AVIC 181 Factory (Wuhan Aviation Instrument Co., LTD.)
 AVIC 607 Institute (China Leihua Electronic Technology Institute)
 AECC 606 Institute (Shenyang Engine Research Institute)
 CETC 14 Institute (Nanjing Institute of Electronic Technology)
 CETC 21 Institute (Shanghai Micromotor Research Institute)
 CETC 23 Institute (Shanghai Transmission Line Research Institute)
 CETC 36 Institute (Jiangnan Institute of Electronic Communication)
 CETC 38 Institute (East China Institute of Electronic Engineering)
 CETC 50 Institute (Shanghai Microwave Technology Research Institute)
 CETC 51 Institute (Shanghai Microwave Equipment Research Institute)
 CETC 54 Institute (Shijiazhuang Communication Measurement and Control Technology Research Institute)
 CETC 55 Institute (Nanjing Institute of Electronic Devices)
 CSIC 707 Institute (Tianjin Institute of Marine Instruments)
 CSIC 719 Institute (Wuhan Second Ship Design Institute)
 CSIC 704 Institute (Shanghai Marine Equipment Research Institute)
 CSIC 726 Institute (Shanghai Marine Electronic Equipment Research Institute)
 Jiangnan Shipbuilding (Group) Co., LTD
 Nanjing Panda Electronics Co., LTD
 State-owned 741 Factory (Nanjing Huadong Electronics Group Co., LTD.)

Chinese People's Liberation Army

South Sea Fleet
 East China Sea Fleet
 North Sea Fleet
 Navy Plant 701 / Plant 702
 4724 Factory (Shanghai Haiying Machinery Factory)
 Unit 95861 (Empty Base 1)

Commercial Aviation



Commercial Aircraft Corporation of China



Collins Aerospace

Rockwell Collins



Guangzhou Aircraft Maintenance Engineering Co., LTD



Beijing Aircraft Maintenance Engineering Co., LTD

Scientific Research & Third Party Quality Inspection Agency



Technical Institute of Physics and Chemistry (Beijing)

Institute of Urban Environment (Xiamen)

Electrotechnical Research Institute (Beijing)

Institute of Applied Physics (Shanghai)

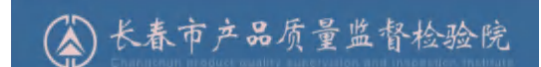
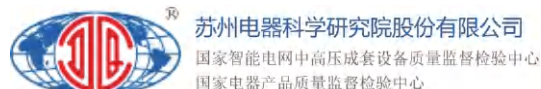
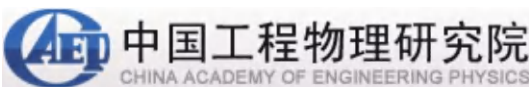

Cooperative Customers (Part)

Military Academies & Local Universities



High-tech R&D Enterprise





Official wechat:hypower-cn



Contact us

Hangyu Power System (Shanghai) Co., Ltd

Mobile/Whatsapp: +8613801800699

Fax: +86-21-67285228-8009

Email:sales@hangyupower.com

neo@hangyupower.com

Address: Building B, 11th Floor, No. 1698 Minyi Road, Songjiang District,
Shanghai.PRCChina

website:www.hangyupower.com

©Hangyu Power System, 2024

Hangyu Power AC Power Supply Product Manual, version 06.00, february 2024

All technical data and instructions are based on the actual product

If there is any change, Hangyu Power has the final interpretation right

Authorized distributor:

