

Baureihen Series S ries

F17LM-9

Flachl fter  
Ultra Slim Fans  
Ventilateur Ultra Plats



SN EN ISO 9001 CERTIFICATED

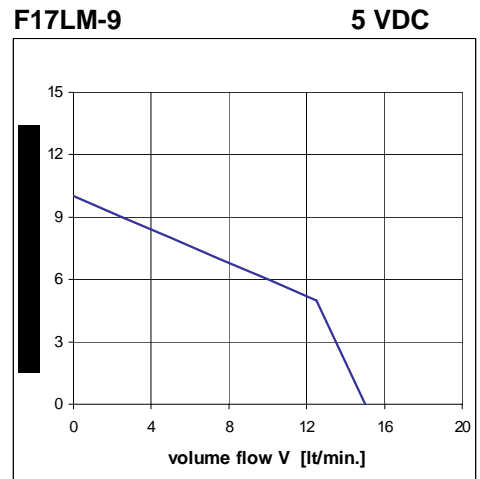
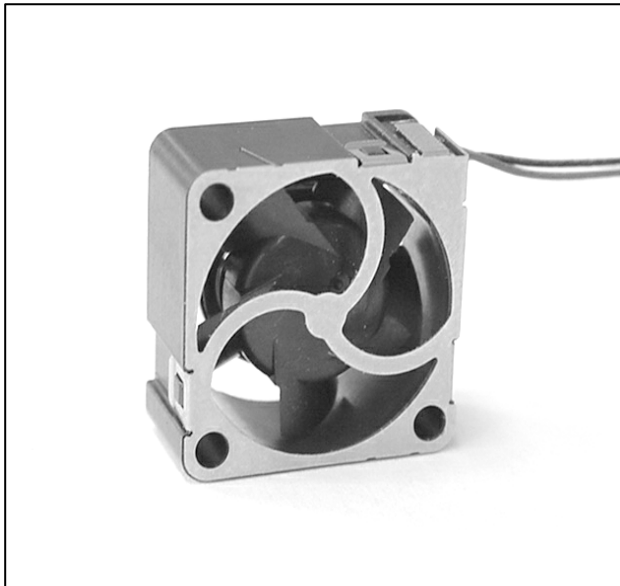

F17

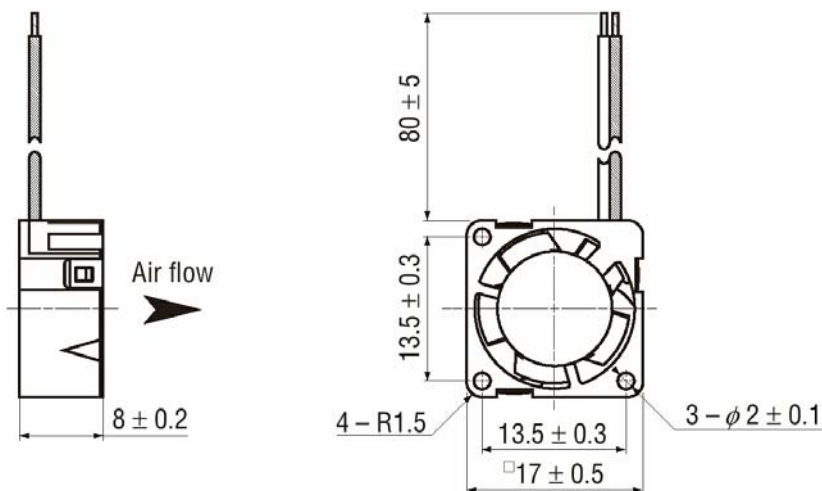





















MICRONEL AG  
CH-8307 Tagelswangen  
www.micronel.ch

Tel. +41-(0)52 355 16 16  
Fax +41-(0)52 355 16 20  
E-mail: info@micronel.com

## Technische Daten

## Technical data

## Carateristiques techniques

			F17 LM	F17 MM
	U <sub>N</sub>	V	5	
	U	V	4.5-5.5	
	I <sub>max</sub>	mA	40	
	I <sub>block</sub>	mA		
	P <sub>N</sub>	W	0.2	
	n	min <sup>-1</sup>	8000	
	V	l/min	15	
	p	Pa	10	
	LpA	db(A)	7	
	MTTF	hr	10'000 / 25°C	
	T	°C/°F	0...+60 / 32...+140	
	m	gr/oz	2.3 / 0.08	
	M	mm/inch	80/3.15 (AWG36)	
	PC		SUS, LCP & ABS/PBT alloy	
	sleeve bearing		O	
	ball bearing		-	
	Option/Tacho/NOS		-	
	Attachment		-	
	Attachment		-	
	Attachment		-	