



XLC-60-KN-S Series
(Independent type)



XLC-60-KN Series
(Built-in type)



Features

- Constant power mode output with multiple stage selectable by ETS database
- Plastic housing with class II and PFC design
- Flicker free, complying with CE ErP directive
- Standby power consumption <0.5W
- Meet emergency lighting (EL) application
- KNX/EIB protocol, support KNX data secure
- Minimum dimming level 0.5%
- Functions: operation hours. power consumption feedback log/linear curve selection. . . etc
- 5 years warranty

Applications

- Recessed Light
- Down Light
- Panel Light
- Commercial Lighting
- Decorative Lighting
- KNX digital Lighting

GTIN CODE

MW Search: <https://www.meanwell.com/serviceGTIN.aspx>

Description

XLC-60-KN Series is a 60W with constant power output LED driver . It can operate from 100 ~ 305VAC and output current ranging between 900mA to 1700mA selectable by ETS database and integration KNX interface to avoid using the complicated KNX-DALI gateway. Thanks to high efficiency up to 90%, it is able to operate for -25°C ~90°C case temperature under free air convection. XLC-60-KN is designed based on latest safety regulations , so it provides more flexibility for LED Lighting application.

Model Encoding

XLC - 60 - H - KN □

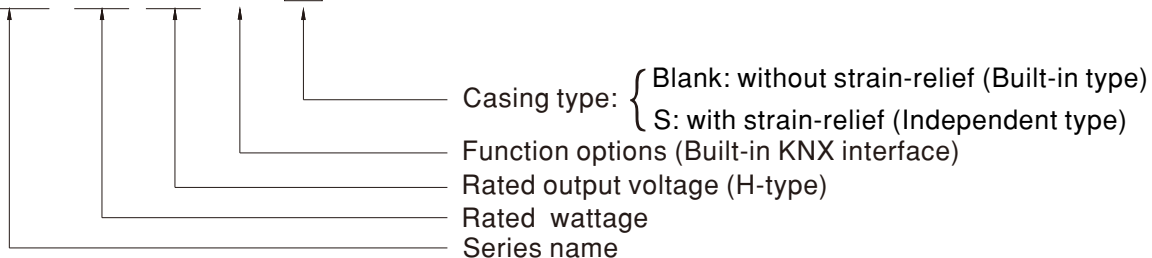

Type	Function	Note
KN	Built-in KNX interface, without strain-relief (Built-in type)	In stock
KNS	Built-in KNX interface, with strain-relief (Independent type)	In stock

SPECIFICATION

MODEL		XLC-60-H-KN □		
OUTPUT	OPEN CIRCUIT VOLTAGE ^{Note2}	60V		
	DEFAULT CURRENT	900mA		
	CURRENT ADJ. RANGE (BY ETS Database)	0.9~1.7A		
	CONSTANT CURRENT REGION	9~54V		
	RATED POWER ^{Note.4}	60W		
	CURRENT RIPPLE ^{Note5}	<4%		
	CURRENT TOLERANCE	±5%		
	DIMMING RANGE	0~100%		
SETUP,RISE TIME ^{Note.6}	800ms,100ms/230VAC ,1000ms,100ms/115VAC			
INPUT	VOLTAGE RANGE	100 ~ 305VAC 155 ~400VDC		
	FREQUENCY RANGE	47 ~ 63Hz		
	POWER FACTOR	PF ≥0.95/115VAC, PF ≥0.95/230VAC, PF ≥0.9/277VAC@full load (Please refer to "POWER FACTOR (PF) CHARACTERISTIC" section)		
	TOTAL HARMONIC DISTORTION	THD< 20%(@load ≥60%/230VAC; @load ≥75%/277VAC); THD<10%@load 100%/230VAC (Please refer to "TOTAL HARMONIC DISTORTION(THD)" section)		
	EFFICIENCY(Typ.) ^{Note7}	90%		
	AC CURRENT	0.75A/115VAC, 0.35A/230VAC, 0.3A/277VAC		
	INRUSH CURRENT	COLD START 15A(twidth=310µs measured at 50% Ipeak) at 230VAC; Per NEMA 410		
	MAX. NO. of PSUs on 16A CIRCUIT BREAKER	25 units (circuit breaker of type B) / 36 units (circuit breaker of type C) at 230VAC		
	LEAKAGE CURRENT	<0.75mA / 277VAC		
	STANDBY POWER ^{Note8} CONSUMPTION	Standby power consumption<0.5W (Dimming off)		
PROTECTION	SHORT CIRCUIT	Hiccup mode, recovers automatically after fault condition is removed		
	OVER TEMPERATURE	Stage 1: De-rating to 75% loading; Stage 2: De-rating to 50% loading. Recovers automatically after fault condition is removed.		
FUNCTION	DIMMING	Please refer to 'DIMMING OPERATION' section		
ENVIRONMENT	WORKING TEMP.	Tcase=-25~90°C (Please refer to "OUTPUT LOAD vs TEMPERATURE" section)		
	MAX. CASE TEMP.	Tcase=90°C		
	WORKING HUMIDITY	20 ~ 90% RH non-condensing		
	STORAGE TEMP., HUMIDITY	-40 ~ +80°C, 10 ~ 95% RH		
	TEMP. COEFFICIENT	±0.03%/°C (0 ~ 50°C)		
	VIBRATION	10 ~ 500Hz, 2G 10min./1cycle, period for 60min. each along X, Y, Z axes		
SAFETY&EMC	SAFETY STANDARDS	ENEC BS EN/EN61347-1, BS EN/EN61347-2-13(EL) appendix J suitable for emergency installations (DC input 176-280VDC); BS EN/EN62384 , GB/T19510.1, GB/T19510.213, EAC TP TC 004 approved; Design refer to AS/NZS 61347-1, AS/NZS 61347-2-13		
	WITHSTAND VOLTAGE	I/P-O/P:3.75KVAC		
	ISOLATION RESISTANCE	I/P-O/P:>100M Ohms / 500VDC / 25°C / 70% RH		
	EMC EMISSION	Parameter	Standard	Test Level/Note
		Conducted	BS EN/EN55015(CISPR15) ,GB/T 17743	-----
		Radiated	BS EN/EN55015(CISPR15) ,GB/T 17743	-----
		Harmonic Current	BS EN/EN61000-3-2 , GB17625.1	Class C @load≥60%
	EMC IMMUNITY	Parameter	Standard	Test Level/Note
		ESD	BS EN/EN61000-4-2	Level 3, 8KV air ; Level 2, 4KV contact
		Radiated	BS EN/EN61000-4-3	Level 2
EFT/Burst		BS EN/EN61000-4-4	Level 2	
Surge		BS EN/EN61000-4-5	Level 3, 1KV/Line-Line	
Conducted		BS EN/EN61000-4-6	Level 2	
Magnetic Field		BS EN/EN61000-4-8	Level 2	
Voltage Dips and Interruptions	BS EN/EN61000-4-11	70% residual voltage for 10 period, 0% residual voltage for 0.5 periods		
OTHERS	KNX	Certified protocol		
	FLICKER ^{Note.9}	PstLM ≤ 1, SVM ≤ 0.4		
	MTBF	4130.5K hrs min. Telcordia SR-332 (Bellcore)	317.7Khrs min. MIL-HDBK-217F (25°C)	
	DIMENSION	176*45*32mm , 136*45*32mm (L*W*H)		
	PACKING	0.28Kg; 40pcs/12.1Kg/0.48CUFT(for blank type);	0.31Kg; 40pcs/13.1Kg/0.61CUFT(for S-type)	
NOTE	<p>1. All parameters NOT specially mentioned are measured at 230VAC input, rated current and 25°C of ambient temperature.</p> <p>2. Output hiccups under no-load condition.</p> <p>3. Please refer to "DRIVER METHODS OF LED MODULE".</p> <p>4. De-rating may be needed under low input voltages. Please refer to "STATIC CHARACTERISTIC" sections for details.</p> <p>5. Current ripple is measured 50%~100% of maximum voltage under rated power delivery.</p> <p>6. Length of set up time is measured at first cold start. Turning ON/OFF the driver may lead to increase of the set up time.</p> <p>7. Efficiency is measured at 1050mA/54V output set by ETS database.</p> <p>8. Standby power consumption is measured at 230VAC.</p> <p>9. Flicker is measured at full load with the light source provided by MEAN WELL.</p> <p>10. The driver is considered as a component that will be operated in combination with final equipment. Since EMC performance will be affected by the complete installation, the final equipment manufacturers must re-qualify EMC Directive on the complete installation again. (as available on https://www.meanwell.com/Upload/PDF/EMI_statement_en.pdf)</p> <p>11. For XLC-S series: RCM is on a voluntary basis. Non IC classification Independent LED control gear is not suitable for residential installations. For XLC(except -S) series: RCM is on a voluntary basis and meets relevant IEC or AS/NZS standards complying with AS/NZS 4417.1.</p> <p>12. The ambient temperature derating of 3.5°C/1000m with fanless models and of 5°C/1000m with fan models for operating altitude higher than 2000m(6500ft).</p> <p>13. This series meets the typical life expectancy of 50000 hours of operation when Tcase, particularly to point (or TMP, per DLC), is about 75°C or less.</p> <p>14. For more information, please contact with MEAN WELL sales.</p> <p>※ Product Liability Disclaimer: For detailed information, please refer to https://www.meanwell.com/serviceDisclaimer.asp</p>			

■ BLOCK DIAGRAM

Fosc : 90KHz

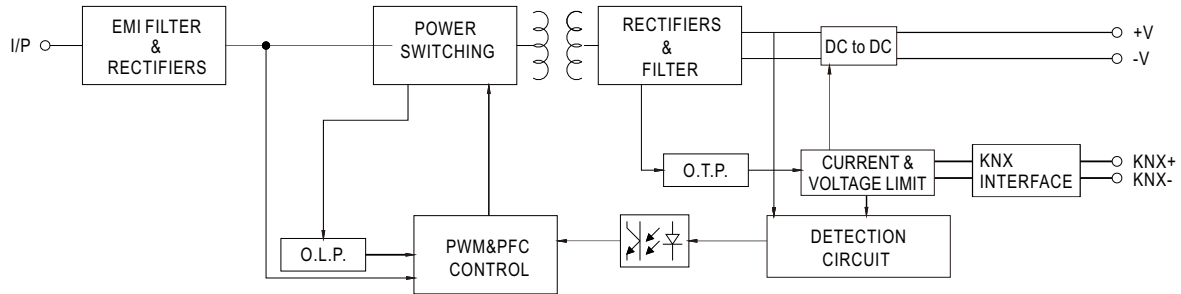

■ DRIVING METHODS OF LED MODULE

※ I-V Operating Area

◎ XLC-60-H-KN

For 60W application

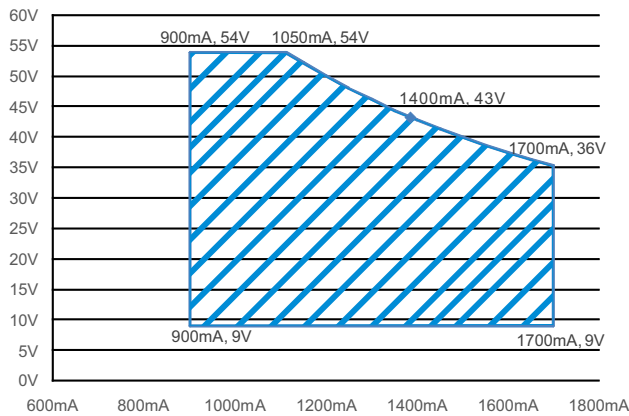

■ CONSTANT POWER TABLE

XLC-60-KN is a multiple-stage constant power driver, selection of output current through Database.

Vo	Io	Vo	Io
9~54V	900mA(Default)	9~45V	1350mA
9~54V	950mA	9~43V	1400mA
9~54V	1000mA	9~41V	1450mA
9~54V	1050mA	9~40V	1500mA
9~54V	1100mA	9~39V	1550mA
9~52V	1150mA	9~38V	1600mA
9~50V	1200mA	9~37V	1650mA
9~48V	1250mA	9~36V	1700mA
9~46V	1300mA		

■ DIMMING OPERATION

※ **KNX interface**

- Apply KNX Bus cable between KNX+ and KNX-
- The application program(database) can be downloaded via Online Catalogs from ETS or via <http://www.meanwell.com/productCatalog.aspx>

Parametrization options	Description
Device Setting	<ul style="list-style-type: none"> • Select current level • Select model • Behavior bus power up
Parameter Setting	<ul style="list-style-type: none"> • Basic Setting <ul style="list-style-type: none"> • normal Dimmer, staircase light • switch function • relative dimming function • absolute dimming function • Feedback Setting <ul style="list-style-type: none"> • dimming value report • on/off state report • lamp failure report • Lock function
Scenes	<ul style="list-style-type: none"> • Learn scene • scene1~scene32
Automatic function	<ul style="list-style-type: none"> • Automatic function1~4
operating hours	<ul style="list-style-type: none"> • Counting of operating hours • Constant light output(CLO) • Life time pre-warning
Power consumption	<ul style="list-style-type: none"> • Voltage, current, power feedback • Energy consumption feedback
Temperature Measurement	<ul style="list-style-type: none"> • customize the alarm temperature • Send temperature report cyclically
Auto-dimming over time	<ul style="list-style-type: none"> • Optional gradient dimming
Correction characteristic	<ul style="list-style-type: none"> • Correction by lux measured value(lux)
Push Dim Port	<ul style="list-style-type: none"> • Push dim • AC monitor

※ **CONSTANT LIGHT OUTPUT**

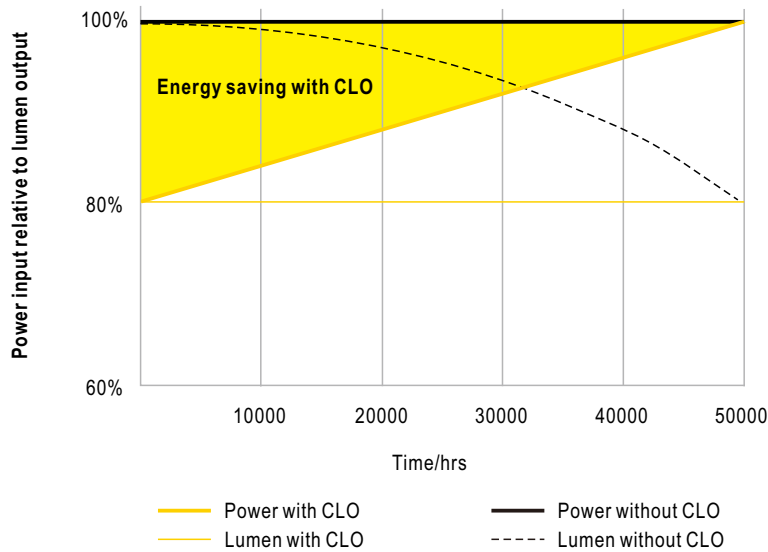

※ **PUSH dimming or AC/DC input monitor(Primary side)**

◎ **PUSH dimming**

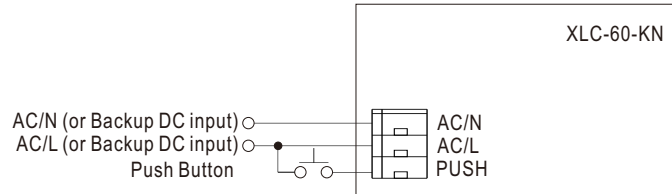

- KNX bus need to be connected when using PUSH Dimming
- The detailed function of PUSH dimming, please refer to the database.
- The maximum length of the cable between the push button and driver is 20 meters.
- The mechanical push button can be connected only between the PUSH terminal, as displayed in the diagram, and AC/L (in brown or black); It will not function properly if it is connected to AC/N.
- In case the PUSH dimming is set locally, up to 10 drivers can perform the PUSH dimming at the same time when utilizing one common push button.
- In case the PUSH dimming is set independently via ETS, the number of drivers is done through group address and determined by the ETS project designer.

◎ **AC/DC input monitor**

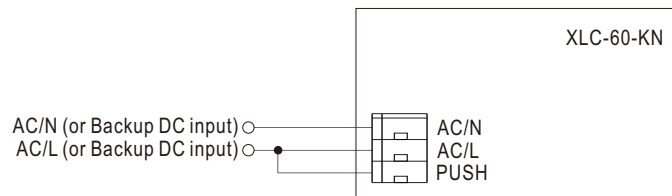

- KNX bus need to be connected when using AC/DC input monitor
- The detailed function of AC/DC input monitor(emergency lighting), please refer to the database and instruction manual.

OUTPUT LOAD vs TEMPERATURE

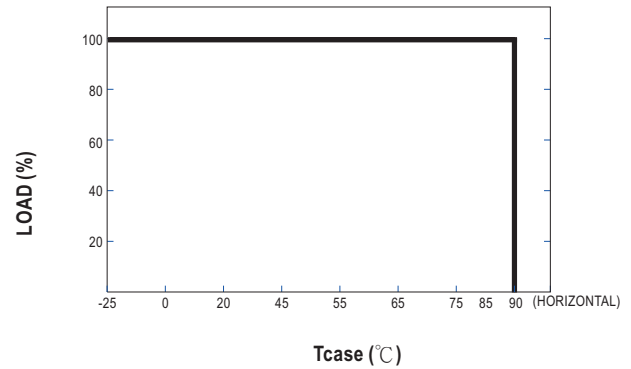
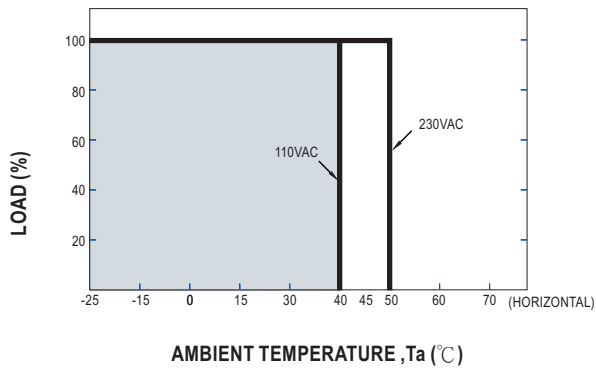

STATIC CHARACTERISTIC

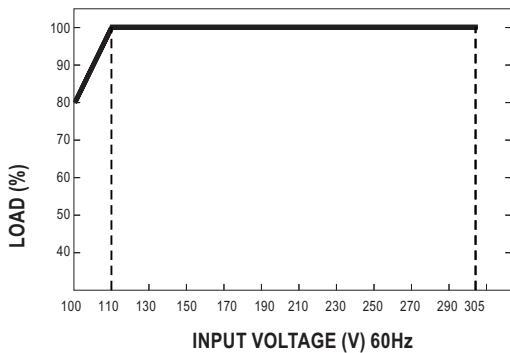

※ De-rating is needed under low input voltage.

LIFE TIME

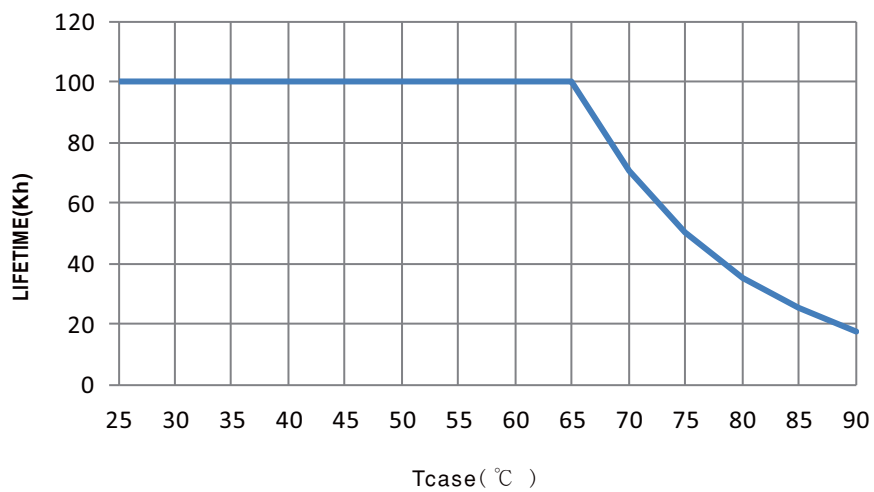

TOTAL HARMONIC DISTORTION (THD)

※ XLC-60-H-KN Model, Tcase at 75°C

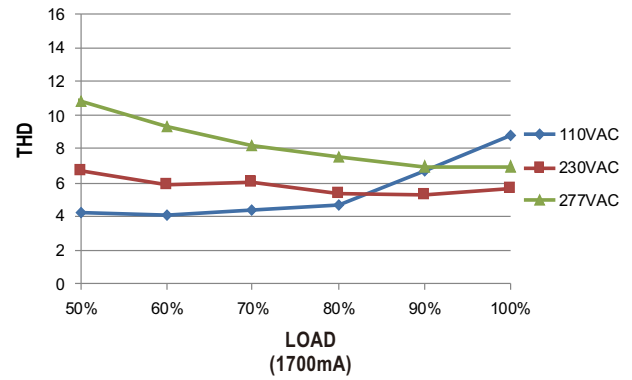
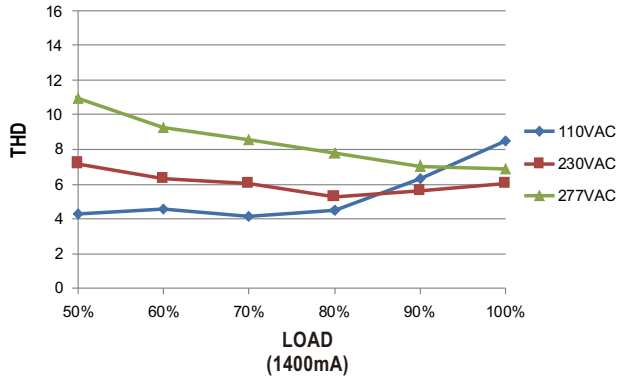

POWER FACTOR (PF) CHARACTERISTIC

※ XLC-60-H-KN Model, Tcase at 75°C

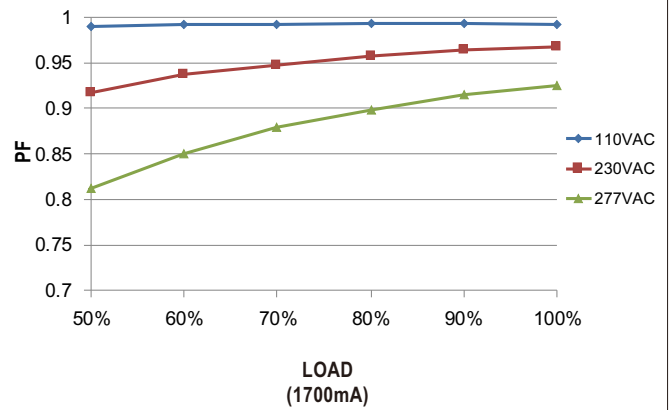
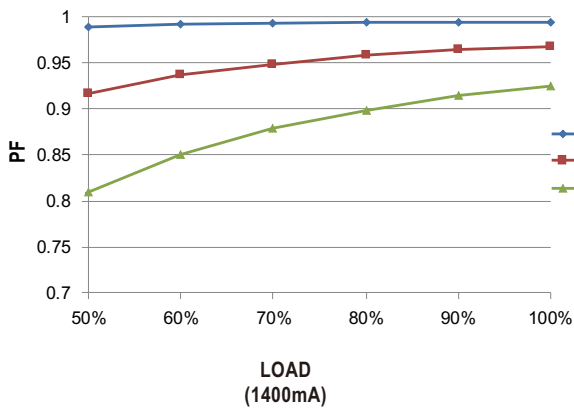

EFFICIENCY vs LOAD

XLC-60-KN series possess superior working efficiency that up to 90% can be reached in field applications.

※ XLC-60-H-KN Model, Tcase at 75°C

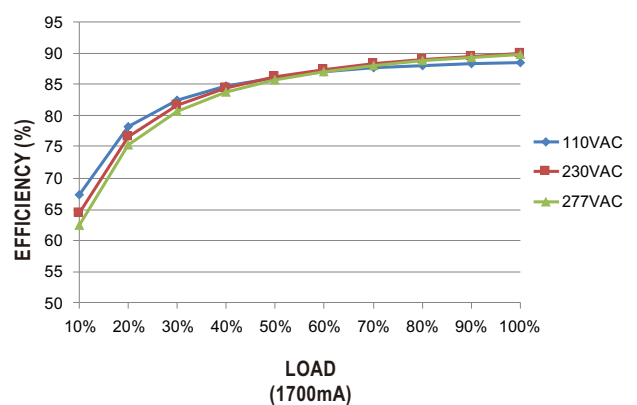
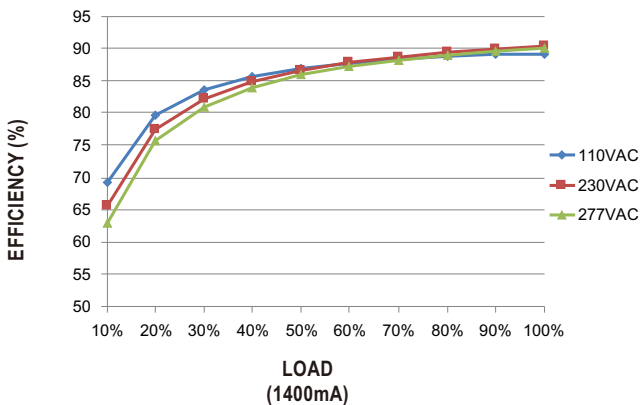

MECHANICAL SPECIFICATION

Case No.XLC-60 Unit:mm Tolerance:±1

※ XLC-60-KN Built-in Type

※ Terminal Pin No. Assignment (TB1)

Pin No.	Assignment
1	AC/N
2	AC/L
3	PUSH

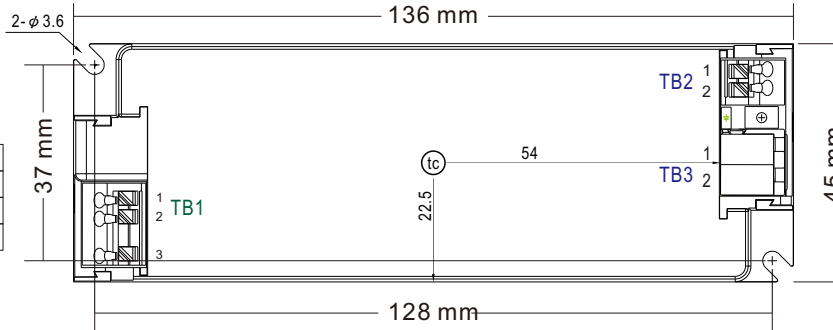

※ Terminal Pin No. Assignment (TB2)

Pin No.	Assignment
1	+V
2	-V

※ Terminal Pin No. Assignment (TB3)

Pin No.	Assignment
1	KNX+
2	KNX-

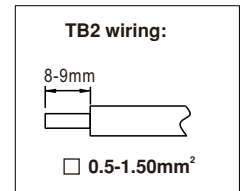
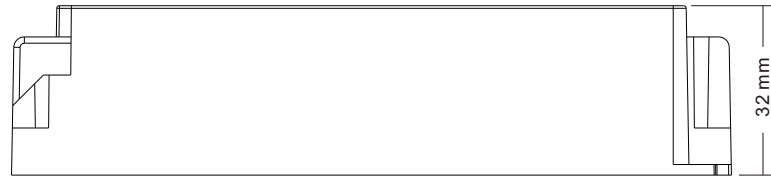
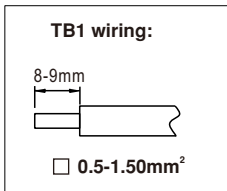

Item	Order No.	Quantity(MOQ/1Bag)
Strain-relief cap	1**3XLC-SET	50pcs (2pcs 1 set)

※ XLC-60-KNS Independent Type

Case No.XLC-60-S Unit:mm

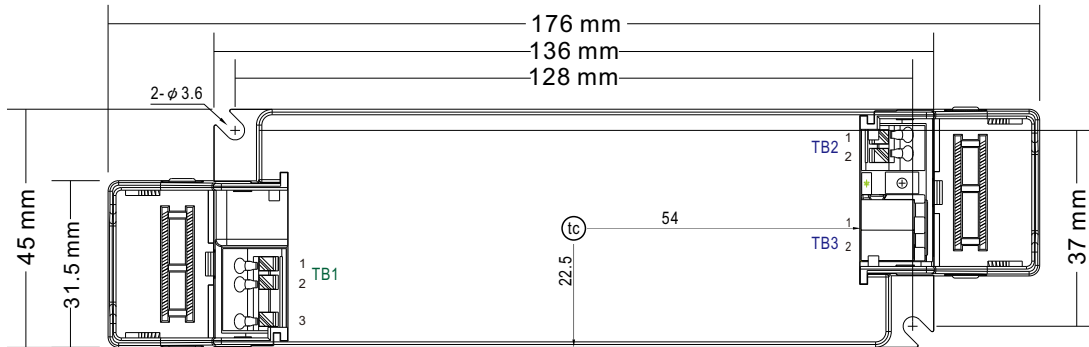

※ Terminal Pin No. Assignment (TB1)

Pin No.	Assignment
1	AC/N
2	AC/L
3	PUSH

※ Terminal Pin No. Assignment (TB2)

Pin No.	Assignment
1	+V
2	-V

※ Terminal Pin No. Assignment (TB3)

Pin No.	Assignment
1	KNX+
2	KNX-

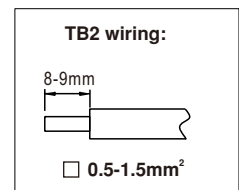
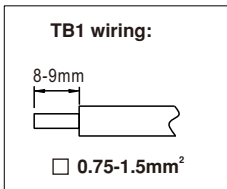

Installation Manual

Please refer to : <http://www.meanwell.com/manual.html>