

Flachl fter
Ultra Slim Fans
Ventilateurs Ultra Plats

Long life / low noise

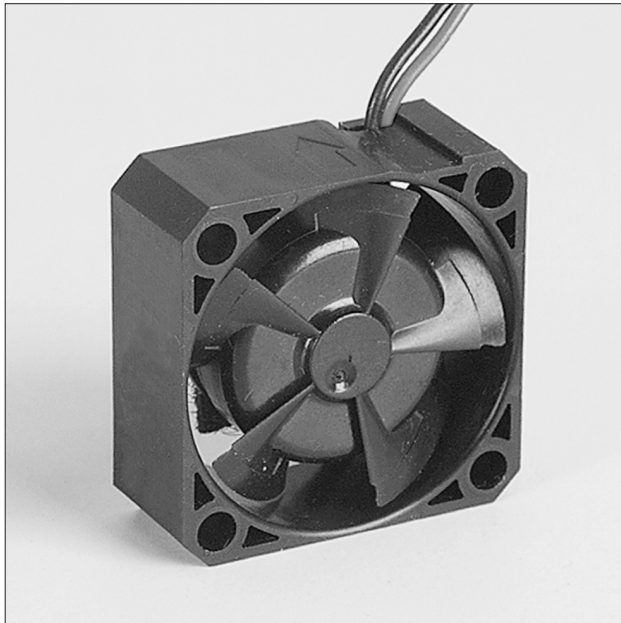

F25 LM/MM 5 V DC

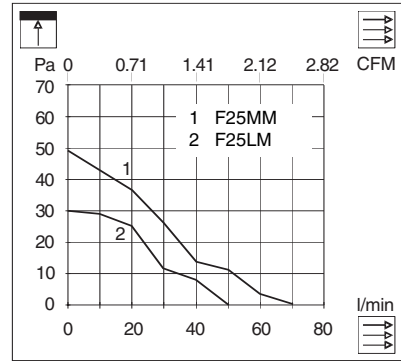

F25 LM/MM 12 V DC

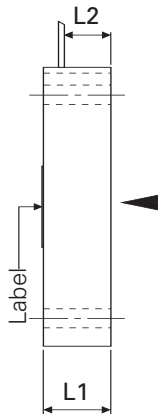
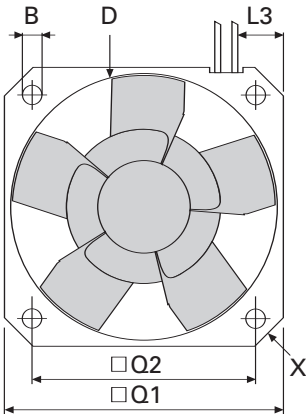
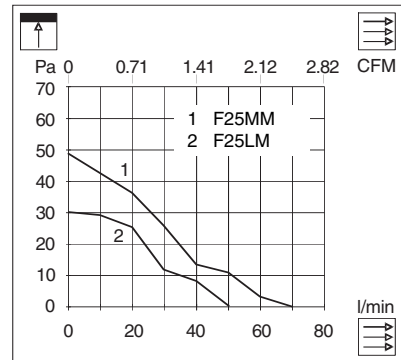























F25 LM/MM	mm	inch
B	2.8	0.11
D	23.5	0.92
L1	10	0.39
L2	8	0.31
L3	7	0.28
Q1	25	0.98
Q2	20	0.79
x	2x45°	0.08x45°

Technische Daten

Technical data

Caractéristiques techniques

			F25 LM / F25 MM		F25 LM / F25 MM	
	U_N	V	5		12	
	U	V	4.2 – 5.7		10.2 – 13.8	
	I_N	mA	50	70	50	60
	I_{max}	mA	100	120	60	80
	I_{block}	mA				
	P_N	W	0.30	0.35	0.50	0.72
	n	min ⁻¹	8000	10000	8000	10000
	\dot{V}	l/min	52	64	52	64
	p	Pa	30	46	30	46
	LpA	dB(A)	15	20	25	20
	MTTF	hr	30000		30000	
	T	°C/°F	-10 / +60		-10 / +60	
	m	gr/oz.	7 / 0.25		7 / 0.25	
	Lead Length	mm/inch	140 / 5.51		140 / 5.51	
	Housing Material		ABS-PBT, black		ABS-PBT, black	
	1 Ball, 1 Sleeve Bearing		•		•	
	Ball Bearing		optional		optional	
	Non Operation Signal 		optional		optional	
	Flat Finger Guard		–		–	
	Circular Finger Guard		–		–	
	Quick Mount		–		–	

Standards

- CE-Zulassung für alle Lüfter
- Motorwicklung nach Isolationsklasse E
- Schutz bei blockiertem Rotor
- Isolationswiderstand min. 10 M Ω bei 500 V DC
- Kriechstromfestigkeit max. 1 mA bei 600 V AC
- Basis $\Delta\rho$, \dot{V} =1.2 kg/m³

Standards

- CE Conformity
- Coils to insulation class E
- Locked rotor protection
- Insulation resistance min. 10 M Ω at 500 V DC
- Dielectric strength max. 1 mA bei 600 V AC
- Basis $\Delta\rho$, \dot{V} =1.2 kg/m³

Standards

- Certificat CE pour tous les ventilateurs
- Bobinage selon la classe d'isolation E
- Protection en cas de blocage du rotor
- Résistance d'isolement min. 10 M Ω sous 500 V DC
- Résistance au courant de fuite: max. 1 mA sous 600 V AC
- Basis $\Delta\rho$, \dot{V} =1.2 kg/m³

 Bitte nachfragen

Please ask

Demander s.v.p.

Umrechnung von Masseinheiten
Conversion of Measuring units
Conversion des unités de mesure

1 mbar = 10.197 mm H₂O = 100 Pa
1 Pa = 10⁻² mbar = 0.10197 mm H₂O
1 hPa = 1 mbar; 1 mm H₂O = 0.04 inch H₂O
1 l/min = 0.0353 CFM; 1 CFM = 28.3 l/min