



# PRODUCT MANUAL

Inclinometer 3D compass Accelerometer Gyro IMU  
GPS/Combined inertial navigation system North Finder

VOL.3.0



OFFICIAL WECHAT ID



CELLPHONE WEBSTE

**BJ RION**

Add:278, section C, building 1, 3rd street, shangdi information industry base, haidian district, Beijing  
Tel: 010-62988656/188-1022-2938 E-mail: sales@rion-star.com

**SZ RION**

Add:Block 1, COFCO(FUAN) Robotics Industrial Park, Da Yang Road 90, Fuyong District, Shenzhen City, China  
Tel:0755-29657137/137-1396-4486 E-mail:sales@rion-tech.net

**SH RION**

Add:3 F, huaqiang building, keyuan road, No 151, pudong new area, Shanghai  
Tel:021-61992106/150-0015-4260 E-mail:husheng@rion-tech.net

**XA RION**

Add:1-1403, baode yungu, jinye road, xi'an high-tech zone  
Tel:029-81870722/189-9127-1128 E-mail:xajf@xaft-tech.com



① The contents of this manual may not be reproduced, transmitted, or stored in a searchable system in any way without the prior written permission of Shenzhen Rulien Technology Co., Ltd. ② The company has made every effort to ensure the accuracy and completeness of the information contained in the manual as of the date of printing. If you find any errors or omissions in the manual, please contact us. We are grateful for this. ③ All pictures in this manual are for reference only, and the actual ones shall prevail. ④ Shenzhen Rulien Technology Co., Ltd. reserves the right to change the product information in the manual at any time without prior notice.

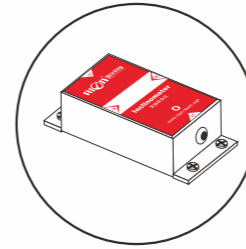

Inclinometer

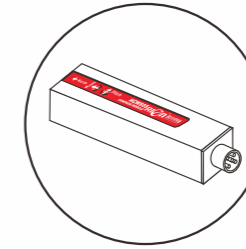

3D compass

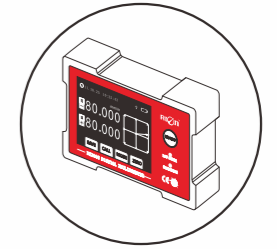

Digital inclinometer

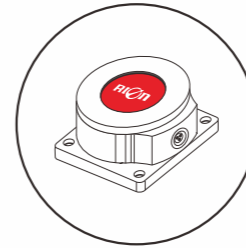

Gyro

*Attitude Solution Provider*  
惯性导航专家!



Accelerometer

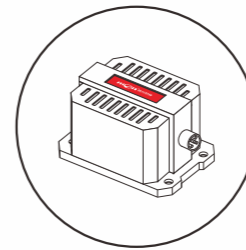

Inertial measurement unit

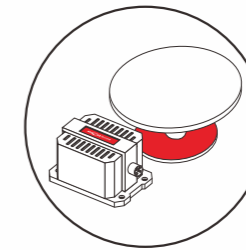

Combined inertial navigation system

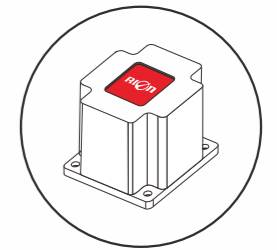

North Finder



瑞芬

## ABOUT RION

SHENZHEN RION Technology Co., Ltd. (hereinafter referred to as "Company") is high-tech enterprise specializing in R&D, production and sales of inertial navigation, INS/GPS integrated navigation system and MEMS tilt and 3D directional compass products. The company's software and hardware R & D strength team is strong, in terms of hardware, the company is equipped with advanced inertial navigation and integrated navigation products production test conditions, with marble test platform, high and low temperature box, ultra-low temperature box, single / three-axis turntable, multiple high-precision automatic More than 30 sets of important equipment such as indexing table, impact vibration table, three-axis non-magnetic calibration table, and vehicle-specific dynamic test equipment. The core technical post engineers in software are led by graduate students and doctoral students, and have reached strategic cooperation with national scientific research units to form a resource sharing platform. Based on technologies such as GPS satellite + INS inertial navigation and algorithm data fusion, the company has developed and designed China. Top-level attitude and orientation integrated navigation system. IMU inertial measurement unit, tilt sensor, 3D anti-magnetic compass and other products. The company is specialized in the production of military supporting electronic technology through ISO9001 and "double soft" certification.

The certification company, the company has 11 software copyrights, a number of national product certification, a number of appearance patent technology, 2 invention patent acceptance certificates, 7 core independent research and development technology: core technology including

1. Inertial guide hardware hardening technology ;
2. High precision RTK positioning and direction measurement technology ;
3. Develop a combination of GNSS carrier phase autonomous model algorithm and inventive carrier phase measurement theory;
4. MEMS gyro independent north homing and heading calculation technology;
5. Low-cost small-volume MEMS combined inertial blind area estimation technology;
6. 3D magnetic compass soft and hard magnetic automatic compensation anti-interference technology;
- 7: High-precision dual-axis tilt angle cross-coupling compensation technology and its supporting software and miniaturized design technology have outstanding advantages.

*Attitude Solution Provider*  
惯性导航专家!

RION 瑞芬科技

- WIDE TEMPERATURE WORK
- THREE PROTECTION
- VIBRATION AND SHOCK RESISTANCE
- FLEXIBLE SYSTEM MATCHING
- GOOD SCALABILITY
- Min Size
- IMPACT RESISTANCE



文化



## The enterprise culture

### CORE OF THE ENTERPRISE

Dedication, integrity, cooperation, innovation

### DEVELOPMENT STRATEGY

- >Adhere to the professional development in the industrial field, and strive to become the industry leader in quality and scale;
- >Market-oriented and technology-oriented, and rationally allocate enterprise resources accordingly.
- >Strengthen international trade cooperation and achieve a global sales network.

### OUR MISSION

Constant innovation, leading the development of the world industry, providing the most competitive products and services to customers around the world;

### OUR PERSPECTIVE

#### PRINCIPLE OF INTEGRITY

- >Sincerely treat partners and establish a good reputation for corporate brands;
- >Mutual trust and sincere cooperation between individuals and departments is the guarantee for establishing an efficient team;
- >Keep your promises and be responsible for your own words and deeds.

### FOREVER IMPROVEMENT

Change is the rule that the market will never change;  
All work, quality and service can always be further improved.

### ENCOURAGE INNOVATION

- >Imitation is always behind, and innovation can develop;
- >Provide a good environment for innovation and allow for failure;
- >Specialized personnel, new things and new practices.



# DISTRIBUTION NETWORK

市场



The "RION" brand product sales network covers the whole world: there are branch offices in Beijing, Xi'an and Shanghai, China, and dealer outlets in East China, South China, North China, Northeast China, Southwest China and Northwest China. More than 30 countries in foreign countries have maintained long-term cooperation with RION, and RION has developed distributors of "RION" brand products in Canada, the United States, Uganda, Russia, Australia, India and South Korea. Providing guarantee services for RION brand products to go international!

## AFTER SALE SERVICES

Providing efficient and comprehensive services and maximizing the protection of users' investment interests is our constant principle. In order to provide users with the highest quality service, we regard service as the most important product, in order to achieve professional, diversified and hierarchical service. Provide users with comprehensive (7X24 hours) technical service and support including consulting, design, project implementation, project maintenance, equipment maintenance, and professional training. And promise to provide the best technical support and after-sales service to ensure that the product is running at its best.

## SERVICES CONTAINS

- >Shenzhen "RION" comprehensive product introduction (including agent products);
- > product catalogue and company introduction materials;
- > "RION" series of pre-sales and after-sales technical consultation and services;
- > product technical proposal, demonstration, and support;
- >Software application explanation;
- >Session support;
- >Product training, on-site guidance;
- >Test of new products;
- >OEM/ODM service.

## SERVICES COMMITMENTS

- >The products supplied by RION are guaranteed for one year warranty and lifetime maintenance;
- > Provide lifelong software upgrade services for RION products and provide technical support; provide technical services for on-site operators;
- >The RION Service Line will provide 365 days, 7 x 24 hours of technical support and online services.

## MAINTENANCE SERVICE

- >Maintenance scope: Shenzhen "RION" comprehensive product introduction (including agent products);
- >Maintenance period: From the date of receipt of the repair products, Shenzhen RION's technical department and normal maintenance department will organize special personnel to repair and return within five working days; (excluding the time during the mailing process);
- >Maintenance costs: "RION" products under warranty period are free of charge due to product quality issues; Due to improper use of the customer, damage to the product to be repaired, only the component fee, no other fees;
- >On-site service: If the product exceeds the maintenance period, if the door-to-door service is required, in addition to the maintenance cost, the customer must also bear the travel expenses of the on-site service personnel; the specific provisions of RION company shall prevail.







RoHS



NATIONAL HIGH-TECH ENTERPRISE



TRADEMARK REGISTRATION CERTIFICATE



NATIONAL WEAK MAGNETIC TESTING REPORT



CALIBRATION REPORT



SOFTWARE PATENT



FCC



NATIONAL ACCURACY TEST REPORT

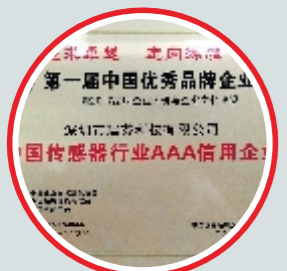

NATIONAL INDUSTRY AAA CREDIT ENTERPRISE

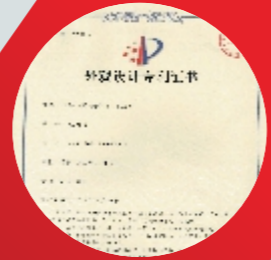

APPEARANCE PATENT CERTIFICATE



ISO9001 QUALITY CERTIFICATION



CE

# CERTIFICATION

荣誉

# RESEARCH POWER

RION Technology attaches great importance to product technology research and development. The company's annual investment in the R&D department accounts for more than 20% of the annual sales. In the same industry, RION has the R&D department with the most R&D talents and the strongest technical strength.

Ensuring the reliability and technological frontier of RION products, RION products greatly enhance the customer's own value, and provide the strongest guarantee for RION products to continuously create more competitive products.

In addition to its strong technical R&D capabilities, RION's R&D department always adheres to the concept of market orientation and technology orientation.

Unswervingly taking the customer's needs as the highest mission, we now have the most complete product line and the most professional technical supporting solutions in the same industry.

The RION test environment is superior, and it has introduced internationally advanced test instruments, and established independent environmental test laboratories, product aging rooms, 2D&3D non-magnetic calibration rooms, and vibration shock laboratories for product development and factory testing.

RION Technology Co., Ltd. also has various constant temperature and humidity testing machines, salt spray corrosion test chambers, high-precision full-temperature turntables, high-precision marble platforms, digital constant temperature drying ovens, electrostatic discharge testers, 360-degree mechanical turntables and other advanced test instruments. In the peer enterprise test equipment is in a leading position. In addition to having an excellent hardware platform, RION has invested a lot of research and development in software.

The company independently developed more than 15 sets of software, ensuring that each product is equipped with professional testing software. Including multi-sensor networking monitoring software, sensor remote monitoring software, 3D dynamic graphics tracking synchronization demonstration software, tilt switch warning debugging software and all sensor serial port setup demonstration software, covering all operating systems XP, Win7, WinCE and the latest Android operation system.

Professional technical team to create professional control software, to provide customers with professional one-stop solution services, to create high-reliability products for the household is the eternal purpose of our research and development team!



# CONTENTS

## INCLINOMETER 10-13

ACA6 series	10-11
ACA8 series	10-11
HCA7 series	10-11
SCA series	12-13
LCA series	12-13
MCA series	12-13

## DYNAMIC INCLINOMETER 14-15

SDA series	14-15
MDA series	14-15
FDA series	14-15

## WIRELESS INCLINOMETER 16-17

SCA126T-WL	16-17
HCA526T-WL	16-17
HCA530T-WL	16-17

## TILT SWITCH 18-19

LCA331A Tilt switch	18-19
LDA331A Dynamic Tilt switch	18-19
DP500 Agric-machine auto level controller	18-19

## DIGITAL INCLINOMETER 20-23

DMI900	20-21
DMI810/820	20-21
DMI410/420	20-21
DMI610	22-23
DAM1000 monitor	22-23

## SOLAR PANEL TRACKING SYSTEM 24-25

SUN-C100	24-25
SUN100	24-25

## 3D ELECTRONIC COMPASS 26-29

DCM250B/DCM260B	26-27
DCM303B/DCM304B	26-27
DCM296B	26-27
HCM370B/HCM375B	28-29
HCM600B/HCM605B	28-29
SDC620B	28-29

## ACCELEROMETER 30-31

AKF190T/AKF198T	30-31
AKF192T	30-31
AKF392T	30-31

## GYRO 32-33

TG632D Gyro	32-33
TL740D Angle meter	32-33
TL750D Angle meter	32-33

## COMBINED INERTIAL NAVIGATION SYSTEM 34-35

GP208T	34-35
INS550D	34-35
GI3310	34-35

## INERTIAL MEASUREMENT UNIT 36-37

AH109B/AH100B	36-37
GI550	36-37
IMU560	36-37

## NORTH FINDER 38-39

MF100	38-39
NF600	38-39
GF800	38-39

## TILT ACQUISITION MONITORING SYSTEM 40-40

TILT ACQUISITION MONITORING SYSTEM	40-40
------------------------------------	-------

目錄





### ★ ACA6 SERIES

The ACA6 series is a full-temperature-compensated high-precision inclinometer developed by RION based on a high-precision tilting platform. It can maintain high measurement accuracy in a wide temperature environment of -40 °C ~ +85 °C. The system has a built-in high-precision 24bit A/D differential converter and the 5th-order filtering algorithm. The output interface RS485, RS232, TTL or CAN optional. It has strong anti-internal electromagnetic interference capability, shock and vibration resistance. It sells well both in domestic and international market for high accuracy-oriented application.

### ★ ACA8 SERIES

The ACA8 series is a full-temperature, high-precision inclinometer developed by RION for high-precision level measurement and leveling. With a high resolution of 0.0005°, it can completely replace the traditional high-precision level. Digital signal transmission, supporting professional computer software, data measurement and recording, the output interface RS485, RS232, TTL or CAN bus is optional.

The non-contact mounting features excellent system integration and easy installation. The screws can be used to fix the sensor to the surface of the object to be measured, and the horizontal angle of the object can be automatically calculated.

Simple to use. It has strong anti-internal electromagnetic interference capability and strong shock and vibration resistance. It has an absolute competitive advantage in domestic counterparts.

### ★ HCA7 SERIES

HCA7 series is RION's small-volume high-precision single/double-axis inclinometer for industrial field control. It adopts RS485/RS232 serial communication interface and MODBUS RTU standard protocol format.

Built-in high-precision 24bit A/D differential converter with 5th-order filtering algorithm to measure the tilt and pitch angle of the sensor output relative to the horizontal plane. The product integrates the latest technology to the main MEMS tilt unit, measuring range of ±90°, full range accuracy of 0.01°, can easily achieve two-axis and single-axis tilt measurement. The products are truly industrial grade products with reliable and stable performance, good expandability and a variety of outputs to choose from. Suitable for photovoltaic panel angle control, photovoltaic panel azimuth tracking, various photothermal power generation mirror angle measurement and large-scale high-precision measurement industrial site.

### ★ FEATURE

- ☆ Single/double axis inclination measurement
- ☆ Resolution 0.001°
- ☆ Range ±10° ~ ±90° optional
- ☆ Wide temperature work -40~+85°C
- ☆ Range ±1° ~ ±15° optional
- ☆ Resolution: 0.0005°
- ☆ RS232/485/422/TTL/
- ☆ CAN bus output optional
- ☆ Single / dual axis inclination measurement
- ☆ Range ±1° ~ ±90° optional
- ☆ DC 9~36V wide voltage input
- ☆ High vibration resistance >100g
- ☆ Direct lead interface

### ★ ORDERING INFORMATION

\*Please refer to the product specification for the specific order model.

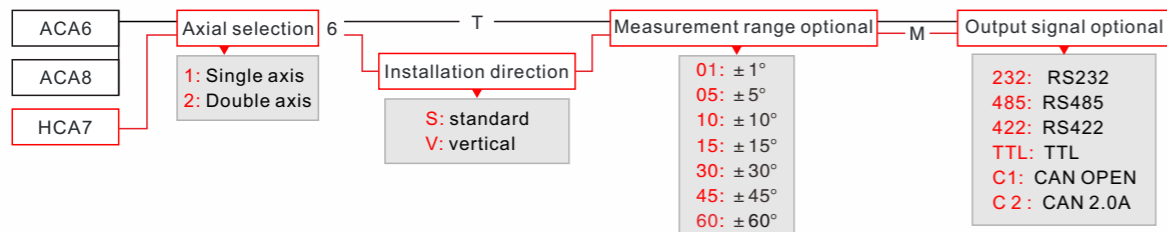

( E.g: ACA626T-05-232: means dual axis, ±05° measurement range, RS232 digital signal output )

### ★ DIMENSIONS

UNIT:mm

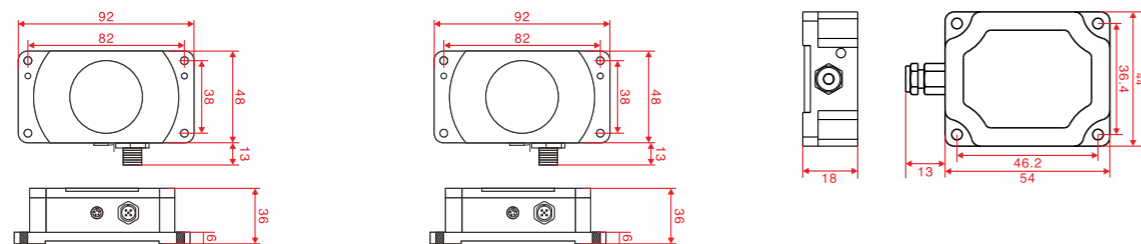

### ★ PERFORMANCE

	ACA626T			ACA826T			HCA726S		
Measuring range	±05°	±30°	±60°	±03°	±10°	±15°	±15°	±60°	±180°
Measuring axis	X Y								
Resolution	0.001°			0.0005°			0.001°	0.003°	0.005°
Accuracy(RMS)	0.003°	0.01°	0.02°	0.001°	0.005°	0.006°	±0.008°	±0.01°	±0.01°
Long-term stability	0.01°	0.02°	0.03°	0.002°	0.003°	0.005°	<0.02°		
Zero temperature coefficient	±0.0008° /°C			±0.0002° /°C			±0.0005° /°C		
Temperature coefficient of sensitivity	≤50ppm/°C			≤30ppm/°C			≤50ppm/°C		
Power-on startup time	0.5s								
Response time	0.02s			0.005s			0.02s		
Output rate	5Hz / 15Hz / 35Hz / 50Hz CAN BE SET								
Output signal	RS232/RS485/RS422/TTL/CAN						RS232/RS485/MODBUS RTU		
Electromagnetic compatibility	According to EN61000 and GBT17626								
MTBF	≥50000 hours / time								
Insulation resistance	≥100 Megohm								
Impact resistance	100g @ 11ms, triaxial and same (half sine wave)								
Anti-vibration	10grms、10 - 1000Hz								
Protection class	IP67 AVIATION PLUG			IP67 AVIATION PLUG			IP67 DIRECT LEAD		
Cable	Standard 1m length, wear-resistant, wide temperature, shielded cable 4 * 0.4mm2 aviation connector								
Weight	220g(Without cable)			220g(Without cable)			95g(Without cable)		
Dimension	L92×W48×H36mm			L92×W48×H36mm			L54×W44×H18mm		

### ★ ELECTRICAL PARAMETERS

	ACA626T	ACA826T	HCA726S
Supply voltage	9~36V		
Working current (no load)	≤50mA		
Operating temperature	-40~+85°C		
Storage temperature	-55~+100°C	-55~+100°C	-40~+85°C

### ★ APPLICATION RANGE

- Satellite search
- Construction vehicle leveling
- Bridge and dam monitoring
- Medical equipment angle control
- Precision machine level control
- Railway locomotive monitoring
- Underground rig attitude navigation
- Rail gauge, gauge gauge leveling
- Geological equipment tilt monitoring
- Radar vehicle platform detection
- Oil drilling equipment
- Angle measurement based on inclination







### ★ SCA SERIES

The SCA series is RION's serial output dual-axis tilt sensor for industrial field control. It has a high-precision A/D differential converter that measures the tilt and pitch angle of the sensor output relative to the horizontal plane through a 5th-order filtering algorithm. Output interfaces RS485, RS232, RS422, TTL, CAN, MODBUS optional.

Thanks to the built-in high-precision digital temperature sensor from ADI, the temperature drift of the sensor can be corrected according to the change of the built-in temperature sensor to ensure high repeatability of the product under low temperature and high temperature environment. The output response frequency standard can reach 50Hz. If you need a higher response frequency, we can customize it according to the user. The products are truly industrial grade products with reliable and stable performance, good expandability, and a variety of outputs to choose from; suitable for a variety of harsh industrial control environments.

### ★ LCA SERIES

The LCA series is a new generation of digital small-volume MEMS tilt sensor from RION. It has a two-channel Earth Gravity Inclination Unit that converts into a tilt angle by measuring static gravitational acceleration. Thereby the tilt and pitch angle of the sensor output relative to the horizontal plane can be measured. The output mode RS232, RS485 or TTL level interface standard is optional. Due to the built-in MCU control system, the linearity of the sensor output is quadraticized, which compensates for the accuracy of the analog type due to insufficient correction.

This product adopts the non-contact measurement principle, which can output the current attitude tilt angle in real time. It is easy to use and does not need to retrieve the two sides of the relative change. It is an ideal choice for industrial automation control and platform measurement attitude. It has strong resistance to external electromagnetic interference and can adapt to long-term work in industrial harsh environment. This product is primarily suitable for dynamic measurements of static and slow changes, not for fast-changing dynamic measurements.

### ★ MCA SERIES

The MCA series is a new generation of digital small-volume MEMS tilt sensor from RION. It has a two-channel Earth Gravity Inclination Unit that converts into a tilt angle by measuring static gravitational acceleration. Thereby the tilt and pitch angle of the sensor output relative to the horizontal plane can be measured. Output mode RS232, RS485 or TTL level interface standard is optional.

Thanks to the built-in MCU control system, the linearity of the sensor output is corrected twice, which compensates for the accuracy of the analog type due to insufficient correction. This product adopts the non-contact measurement principle, which can output the current attitude tilt angle in real time. It is easy to use and does not need to retrieve the two sides of the relative change. It is an ideal choice for industrial automation control and platform measurement attitude. It has strong resistance to external electromagnetic interference and can adapt to long-term work in industrial harsh environment. This product is primarily suitable for dynamic measurements of static and slow changes, not for fast-changing dynamic measurements.

### ★ FEATURE

- ☆ Single / Dual Axis Inclination Measurement
- ☆ IP67 Protection Level
- ☆ Absolute Accuracy 0.05°
- ☆ Output Type Rs232/rs485/ Rs422/ttl/can Optional
- ☆ Single / Dual Axis Inclination Measurement
- ☆ Range ± 1 ~ ± 90° Optional
- ☆ Resolution 0.1°
- ☆ long-term Stability 0.2°
- ☆ Small Size, Can Be Customized
- ☆ Single / Dual Axis Inclination Measurement
- ☆ Range ± 1 ~ ± 90° Optional
- ☆ DC 9~36v Wide Voltage Input
- ☆ High Vibration Resistance>2000g

### ★ ORDERING INFORMATION

\*Please refer to the product specification for the specific order model.

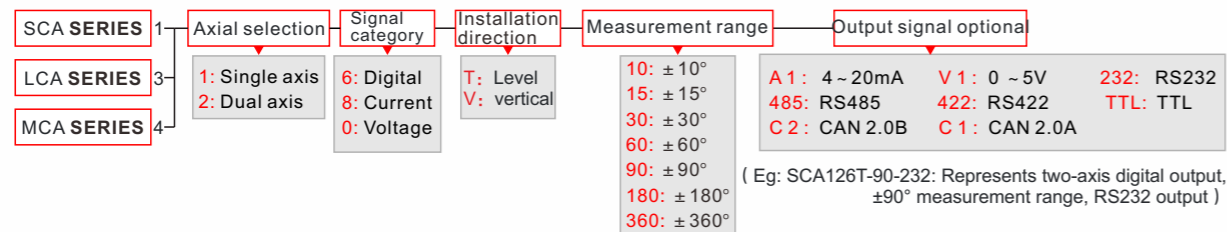

### ★ DIMENSIONS

UNIT:mm

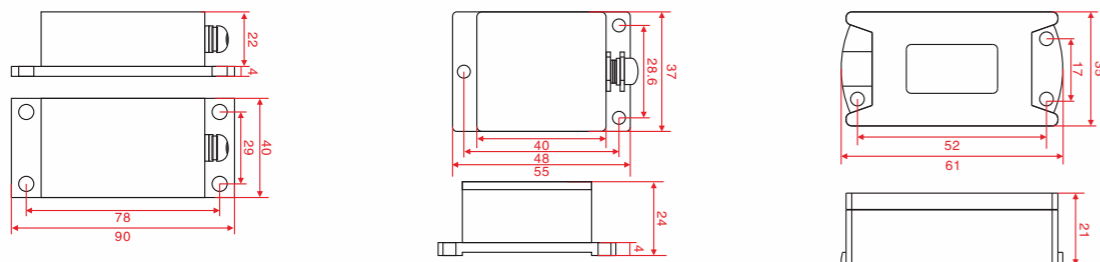

★ PERFORMANCE	SCA126T			LCA326T			MCA426T		
Measuring range	±10°	±30°	±60°	±10°	±30°	±60°	±30°	±60°	±90°
Measuring axis	X Y								
Resolution	0.01°			0.01°			0.1°		
Accuracy(RMS)	0.02°	0.05°	0.08°	0.1°	0.1°	0.3°	±0.2°	±0.3°	±0.5°
Long-term stability	0.05°			<0.2°			<0.5°		
Zero temperature coefficient	±0.006° /°C			±0.01° /°C			±0.01° /°C		
Temperature coefficient of sensitivity	≤100 ppm/°C			≤150 ppm/°C			≤150 ppm/°C		
Power-on startup time	0.5S			0.5S			1S		
Response time	0.02S			0.02S			0.05S		
Output rate	5Hz/15Hz/35Hz/50Hz CAN BE SET								
Output signal	RS232/RS485/RS422/TTL/CAN						RS232/RS485/TTL/MODBUS		
Electromagnetic compatibility	According to EN61000 and GBT17626								
MTBF	≥50000 hours / time								
Insulation resistance	≥100 Megohm								
Impact resistance	100g @ 11ms, triaxial and same (half sine wave)								
Anti-vibration	10grms、10 - 1000Hz								
Protection class	IP67 DIRECT LEAD								
Cable	Standard 1m length, wear-resistant, wide temperature, shielded cable								
Weight	170g(Without cable)			90g(Without cable)			150g(Without cable)		
Dimension	L90×W40×H26mm			L55×W37×H24mm			L61×W35×H21mm		

★ ELECTRICAL PARAMETERS	SCA126T	LCA326T	MCA426T
Supply Voltage	9~36V	5V	9~36V
Working Current (no Load)	≤40mA		
Operating Temperature	-40~+85°C		
Storage Temperature	-55~+125°C	-55~+100°C	-40~+85°C

### ★ APPLICATION RANGE

- |                               |                                      |  |
|-------------------------------|--------------------------------------|--|
| Torque Limiter                | Four-wheel Positioning System        | Solar Thermal And Photovoltaic Tracking            |
| Shield Jacking Application    | Railway Locomotive Monitoring        | Various Engineering Machinery Angle Control        |
| Medical Equipment Leveling    | Geological Equipment Tilt Monitoring | Artillery Barrel Initial Firing Angle Measurement  |
| Satellite Antenna Positioning | Ship Navigation Attitude Measurement | Satellite Communication Vehicle Attitude Detection |





**DYNAMIC INCLINOMETER**



★ SDA series

The SDA series is RION's newly developed dynamic tilt sensor, which is a CAN bus output type dual-axis tilt sensor for industrial field control.

This product can be used in fast motion engineering machinery vehicles. Compared with static tilt switch, it can resist the influence of acceleration and can resist vibration.

The industry standard isolated CAN transceiver with built-in high-precision A/D differential converter, through the 5th-order filtering algorithm, can measure the tilt and pitch angle of the sensor output relative to the horizontal plane.

Built-in ADI's high-precision digital temperature sensor can correct the sensor temperature drift according to the change of the built-in temperature sensor to ensure high repeatability of the product in low temperature and high temperature environment. The output response frequency standard can reach 100Hz. If you need a higher response frequency, we can customize it according to the user. The true industrial grade products are reliable, stable, and expandable. A variety of outputs are available for a variety of harsh industrial control environments.

★ MDA series

The MDA series is a new dynamic measuring small-volume MEMS tilt sensor from RION that accurately measures the attitude of the motion carrier. The built-in dual-channel Earth Gravity Inclination Unit converts into a tilt angle change by measuring static gravitational acceleration. Thereby the tilt and pitch angle of the sensor output relative to the horizontal plane can be measured.

Output mode RS232, RS485 level interface standard is optional. Due to the built-in MCU control system, the linearity of the sensor output is quadraticized, which compensates for the accuracy of the analog type due to insufficient correction. This product adopts the non-contact measurement principle, which can output the current attitude tilt angle in real time, which is easy to use.

There is no need to retrieve two facets for relative changes. It is an ideal choice for industrial automation control and platform measurement attitude. It has strong resistance to external electromagnetic interference and can work in industrial harsh environment for a long time. This product is primarily suitable for dynamic measurements of static and slow changes.

★ FDA series

The FDA series is a high-precision dynamic measuring inclinometer developed by RION based on a high-precision tilting platform. Its excellent temperature stability can maintain high measurement accuracy in a wide temperature range of -40 ° C to 85 ° C. More suitable for long-term monitoring and leveling of field equipment.

In addition, the system has a built-in high-precision 24bit A/D differential converter, and through the 5th-order filtering algorithm, it can measure the tilt and pitch angle of the sensor output relative to the horizontal plane. The output interface RS485, RS232, TTL, CAN bus is optional.

The non-contact mounting features make the FDA Series an excellent system integration. Simply fix the sensor to the surface of the object to be measured with a screw and automatically calculate the attitude tilt of the object. It is easy to use.

There is no need to retrieve two facets for relative changes.

It has strong anti-internal electromagnetic interference capability and strong shock and vibration resistance. It has an absolute competitive advantage in domestic counterparts and is professionally applied to the industrial and military fields required by high-end users.

★ FEATURE

- ☆ Dynamic Biaxial Inclination Measurement
- ☆ maximum Range ± 90°
- ☆ Dynamic Accuracy: < ± 0.5°
- ☆ Resolution 0.01°
- ☆ IP67

- ☆ Dynamic Biaxial Inclination Measurement
- ☆ maximum Range ± 90°
- ☆ Dynamic Accuracy: < ± 1.5°
- ☆ Resolution 0.1°
- ☆ IP67

- ☆ Dynamic Biaxial Inclination Measurement
- ☆ maximum Range ± 90°
- ☆ Dynamic Accuracy: < ± 0.05°
- ☆ Resolution 0.001°
- ☆ IP67

★ ORDERING INFORMATION

\*Please refer to the product specification for the specific order model.

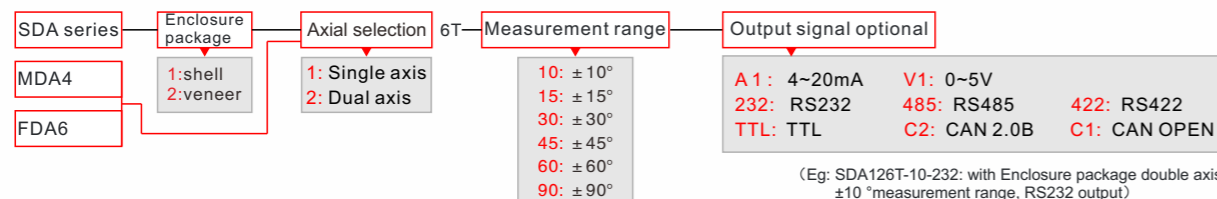

★ DIMENSIONS

UNIT:mm

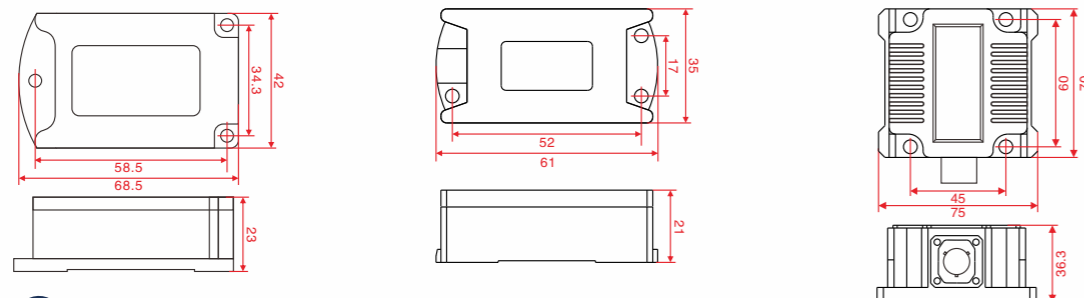

★ PERFORMANCE

	SDA126T	MDA426T	FDA626T
Measuring range	±90°	±90°	±90°
Measuring axis	X Y	X Y	X Y
Resolution	0.01°	0.1°	0.001°
Static accuracy(RMS)	0.1°	±0.3°	±0.01°
Dynamic accuracy(RMS)	<0.5°	<±1.5°	<±0.1°
Long-term stability	0.05°	0.5°	0.01°
Zero temperature coefficient	±0.006°/°C	±0.01°/°C	±0.001°/°C
Temperature coefficient of sensitivity	≤100ppm/°C		
Power-on startup time	0.5s	1s	0.5s
Response time	0.01s	0.01s	0.01s
Output rate	5Hz/15Hz/35Hz/50Hz CAN BE SET		
Output signal	RS232/RS485/RS422/TTL/CAN		
Electromagnetic compatibility	According to EN61000 and GBT17626		
MTBF	≥50000 hours / time		
Insulation resistance	≥100 Megohm		
Impact resistance	100g @ 11ms, triaxial and same (half sine wave)		
Anti-vibration	10grms, 10 ~ 1000Hz		
Protection class	IP67 AVIATION PLUG, IP67 DIRECT LEAD		
Cable	Standard 1m length, wear-resistant, wide temperature, shielded cable		
Weight	170g(Without cable)	150g(Without cable)	224g(Without cable)

★ ELECTRICAL PARAMETERS

	SDA126T	MDA426T	FDA626T
Supply Voltage		9~36V	
Working Current (no Load)	≤40mA	≤40mA	≤50mA
Operating Temperature		-40~+85°C	
Storage Temperature	-55~+125°C	-40~+85°C	-55~+100°C

★ APPLICATION RANGE

- Satellite Search
- Shield Jacking Application
- Four-wheel Positioning System
- Railway Locomotive Monitoring
- Radar Vehicle Platform Detection
- Underground Rig Attitude Navigation
- Geological Equipment Tilt Monitoring
- Ship Navigation Attitude Measurement
- Angle Measurement Based On Inclination
- Artillery Barrel Initial Firing Angle Measurement
- Satellite Communication Vehicle Attitude Detection
- Various Engineering Machinery Inclination Measurement







★ SCA126T-WL

SCA126T-WL is a wireless transmission dual-axis tilt sensor developed by our company based on SCA126T. It adopts wireless ISM full-band operating frequency and conforms to the global ISM band communication standard.

No need to apply for frequency. The carrier frequency is within 400~480MHZ. The communication distance in the visible space is up to 200 meters.

The GFSK modulation method uses efficient forward error correction channel coding technology to improve the ability of data to resist burst interference and random interference. The accelerometer structure is made of aluminum alloy and has a waterproof structure. It can be used outdoors for monitoring applications. The product is divided into a wireless inclinometer and a wireless data receiver. The receiver consists of a receiving antenna and an aeronautical connector. The receiver outputs the acceleration measurement value of the wireless module through the RS232/RS485/RS422/TTL interface. The user only needs to provide power and collect it. The digital signal can measure and analyze the acceleration and vibration changes of remote objects in real time.

★ FEATURE

- ☆ Dual Axial Inclination Measurement
- ☆ Range  $\pm 1 \sim \pm 90^\circ$  Optional
- ☆ Highest Precision:  $0.02^\circ$
- ☆ Resolution:  $0.01^\circ$
- ☆ Empty 200 Meters Wireless Transmission

★ HCA526T-WL

HCA526T-WL is a dual-axis tilt sensor developed by our company on the basis of HCA526T. It adopts wireless ISM full-band operating frequency and conforms to the global ISM band communication standard. It does not need to apply for frequency. The carrier frequency is within 400~480MHZ. The communication distance in the visible space is up to 200 meters.

The inclinometer is equipped with a high-precision 16-bit A/D differential converter that measures the tilt and pitch angle of the sensor output relative to the horizontal plane through a 5th-order filtering algorithm. The sensor temperature drift is corrected based on the built-in ADI's high-precision digital temperature sensor to ensure high repeatability in low temperature and high temperature environments. The output response frequency standard can reach 18Hz. If you need a higher response frequency, we can customize it according to the user. Real industrial grade products with reliable performance and good expandability; suitable for use in a variety of harsh industrial control environments. A variety of harsh industrial control environments.

- ☆ Dual Axial Inclination Measurement
- ☆ Range  $\pm 1 \sim \pm 60^\circ$  Optional
- ☆ Highest Precision:  $0.005^\circ$
- ☆ Resolution:  $0.001^\circ$
- ☆ 200 Meters Wireless Transmission In The Open Area

★ HCA530T-WL

The HCA530T-WL is a wireless transmission type dual-axis tilt sensor for the industrial control field. It adopts the wireless ISM full-band operating frequency and conforms to the global ISM band communication standard, and does not need to apply for frequency. The carrier frequency is within 400~480MHZ. The communication distance in the visible space is up to 20 meters.

And built-in battery solution, battery charging time is about 5h, battery life > 35h. The inclinometer has a built-in high-precision 16-bit A/D differential converter that measures the tilt and pitch angle of the sensor output relative to the horizontal plane through a 5th-order filtering algorithm;

The sensor corrects the temperature drift of the sensor according to the change of the built-in temperature sensor to ensure high repeatability of the product under low temperature and high temperature environment. The output response frequency standard can reach 18Hz. If you need a higher response frequency, we can customize it according to the user. Industrial grade products, reliable and stable performance, good expandability, a variety of output options; suitable for a variety of harsh industrial control environments.

- ☆ Dual Axial Inclination Measurement
- ☆ Range  $\pm 1 \sim \pm 60^\circ$  Optional
- ☆ Highest Precision:  $0.005^\circ$
- ☆ Resolution:  $0.001^\circ$
- ☆ Empty 200 Meters Wireless Transmission
- ☆ Battery Life: >35h (can Be Customized)
- ☆ Battery Charging Time: 5h

★ ORDERING INFORMATION

\*Please refer to the product specification for the specific order model.

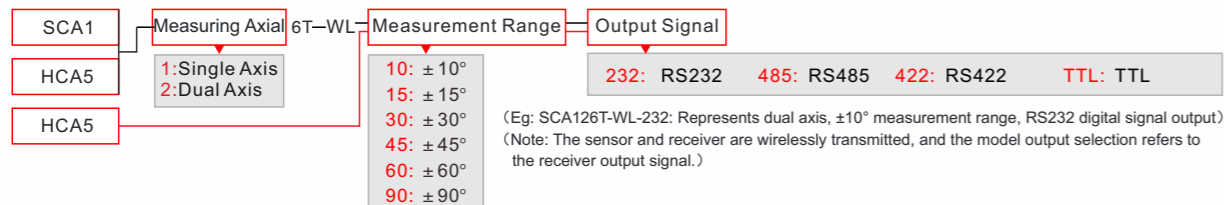

★ DIMENSIONS

UNIT:mm

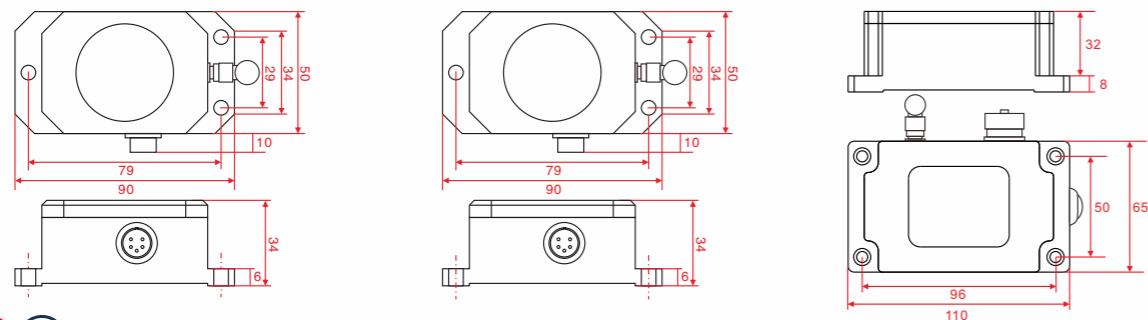

★ PERFORMANCE

	SCA126T-WL			HCA526T-WL			HCA530T-WL		
Measuring range	$\pm 10^\circ$	$\pm 30^\circ$	$\pm 90^\circ$	$\pm 10^\circ$	$\pm 30^\circ$	$\pm 60^\circ$	$\pm 10^\circ$	$\pm 30^\circ$	$\pm 60^\circ$
Measuring axis	X Y								
Resolution	0.01°			0.001°			0.001°		
Accuracy(RMS)	0.02°	0.05°	0.08°	0.005°	0.01°	0.02°	0.005°	0.01°	0.02°
Long-term stability	0.05°	0.05°	0.05°	0.01°	0.02°	0.05°	0.01°	0.02°	0.05°
Zero temperature coefficient	$\pm 0.003^\circ/\text{C}$			$\pm 0.001^\circ/\text{C}$			$\pm 0.001^\circ/\text{C}$		
Temperature coefficient of sensitivity	$\leq 100\text{ppm}/\text{C}$			$\leq 50\text{ppm}/\text{C}$			$\leq 50\text{ppm}/\text{C}$		
Power-on startup time	0.5s								
Response time	0.02s								
Output rate	5Hz/15Hz/35Hz/50Hz Settable								
Output signal	RS232/RS485/RS422/TTL								
Wireless transmission distance	200m(Open area)								
MTBF	$\geq 50000\text{Hour / time}$								
Insulation resistance	$\geq 100\text{Megohm}$								
Impact resistance	100g@11ms, triaxial and same (half sine wave)								
Anti-vibration	10grms, 10 - 1000Hz								
Waterproof level	IP67 AVIATION PLUG								
Cable	Standard 1m length, wear-resistant, wide temperature, shielded cable								
Weight	234g(Without cable)			234g(Without cable)			349g(Without cable)		
Dimension	L90×W50×H34mm			L90×W50×H34mm			L110×W65×H40mm		

★ ELECTRICAL PARAMETERS

	SCA126T-WL	HCA526T-WL	HCA530T-WL
Supply Voltage		9~3V	
Working Current (no Load)		50mA	
Operating Temperature		-40~+85°C	
Storage Temperature		-55~+125°C	

★ APPLICATION RANGE

Satellite Search	Construction Vehicle Leveling	Ship Navigation Attitude Measurement
Oil Drilling Equipment	Precision Machine Level Control	Geological Equipment Tilt Monitoring
Bridge And Dam Monitoring	Railway Locomotive Monitoring	Artillery Barrel Initial Firing Angle Measurement
Radar Vehicle Platform Detection	Underground Rig Attitude Navigation	Satellite Communication Vehicle Attitude Detection





★ LCA331A

The LCA331A is a digital dual-axis tilt switch developed by RION's integrated import control core unit for industry applications related to horizontal safety alarms and platform leveling detection. The user can set the alarm angle threshold by himself.

When the safety angle value is exceeded, the switch quantity signal (output voltage=supply voltage) is output, the electromagnetic valve is driven to shut off the hydraulic system, and the buzzer and the alarm light can be driven to automatically alert the operator to safe construction.

This product is mainly used to control the level of various engineering machinery or equipment platforms, and automatically monitors the tilting state of the front, rear, left and right directions in real time.

The product design is precise, the temperature and linearity are compensated again, and the comprehensive protection functions such as short circuit, instantaneous high voltage, polarity and swell are integrated, which is suitable for various harsh industrial environments. In the reliability and stability of the product, industrial grade MCU, three anti-PCB board, imported cable, wide temperature metal casing and other measures are also used to improve the industrial grade of the product.

★ FEATURE

- ☆ Resolution 0.05 °
- ☆ Direct Lead Interface
- ☆ customer Can Set The Alarm Angle Value
- ☆ with Setting Zero Degree Function
- ☆ switch Output (high And Low Level)

★ LDA331A

LDA331A is a high-precision dynamic dual-axis tilt switch developed by RION's integrated import control core unit for horizontal safety alarm and platform leveling detection related industry applications.

The user can set the alarm angle threshold. When the safety angle value is exceeded, the switch signal (output voltage = supply voltage) will be output. The solenoid valve will be driven to shut off the hydraulic system. The buzzer and alarm light can also be driven to warn the operator. Conduct safe construction.

This product is mainly used to control the level of various engineering machinery or equipment platforms, and automatically monitors the tilting state of the front, rear, left and right directions in real time. The product design is precise, the temperature and linearity are compensated again, and the comprehensive protection functions such as short circuit, instantaneous high voltage, polarity and swell are integrated, which is suitable for various harsh industrial environments.

In the reliability and stability of the product, industrial grade MCU, three anti-PCB board, imported cable, wide temperature metal casing and other measures are also adopted to improve the industrial grade of the product.

★ DP500

DP500 agricultural machine leveling control for horizontal angle control of agricultural machines when driving automatically.

The product consists of a digital display and a dynamic tilt sensor. The threshold of the adjustment angle can be easily set on the display, and the speed and amplitude of the callback can be set so that it can be adapted to the hydraulic adjustment speed of each machine.

The dynamic tilt sensor integrates an inclinometer and a dynamic gyroscope, which can output a stable horizontal angle during high-speed driving or cornering maneuvering. The measured use proves that the adjustment rate is high and the action is stable.

Dp500 is a horizontal controller specially developed for the leveling of agricultural machinery and tools. It is suitable for paddy field equipment, ploughing machine tools, harvesting machine sprinklers, etc. The products have reliable performance and can be used in harsh environments for a long time.

- ☆ Single Axis Dynamic Inclination Measurement
- ☆ Switch Output (high And Low Level)
- ☆ With Zero Function
- ☆ Led Alarm
- ☆ Horizontal Bubble Zero Reference
- ☆ All Kinds Of Agricultural Machinery And Equipment Leveling
- ☆ Output Stable Horizontal Angle When The Carrier Runs At High Speed
- ☆ high Adjustment Rate And Smooth Operation

★ ORDERING INFORMATION

\*Please refer to the product specification for the specific order model.

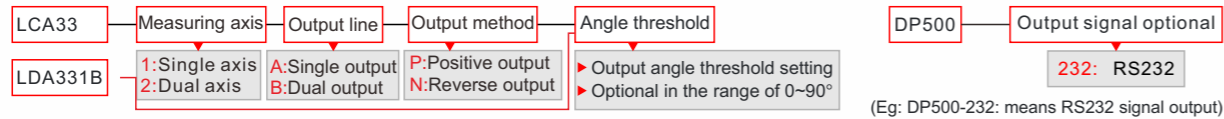

(Eg: LCA331A-P005: means single axis / single / forward output / 0.5 degree alarm)

★ DIMENSIONS

UNIT:mm

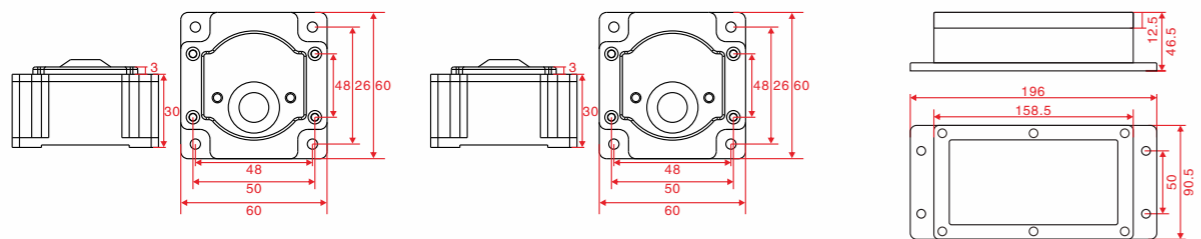

★ PERFORMANCE	LCA331A	LDA331A	★ PERFORMANCE	DP500
Measuring range	± 15°	± 80°	Angle sensor interface	RS232
Measuring axis	X、Y	Single Axis	Power interface	2-pin Power Connector
Output port	Single / dual voltage output	Dual voltage output	Solenoid valve interface	3-core Solenoid Valve Interface
Resolution	0.05°	0.1°	Master switch button	Rocker Switch
Accuracy(RMS)	0.1°	< 0.3° ( Sport mode )	Data display	Four Digital Tube
Zero temperature coefficient	-40 ~ 85° ± 0.01° /°C	-40 ~ 85° ± 0.01° /°C	Semaphore	Level Indicator
Temperature coefficient of sensitivity	-40 ~ 85° ≤ 100ppm/°C	-40 ~ 85° ≤ 100ppm/°C	Manual / automatic switch	Toggle Switch
Power-on startup time	0.1s		Clear button	3 Seconds Reset Button
Response time	0.2s		Impact resistance	100g @ 11ms, triaxial And Identical (half Sine Wave)
Electromagnetic compatibility	According to EN61000 and GBT17626		Anti-vibration	10grms、10 ~ 1000hz
MTBF	≥ 50000Hour / time		Cable	3 M 2 Core Cable
Insulation resistance	≥ 100Megohm		Protection class	IP65
Impact resistance	100g @ 11ms, triaxial and same (half sine wave)		Shell material	ABS environmental protection plastic
Anti-vibration	10grms、10 ~ 1000Hz		Dimension	L196*W90.5*H46.5mm
Protection class	Direct lead IP67		Weight	358g(Without cable)
Cable	Tandard 1m Long, Wear-resistant, Oil-proof, Wide Temperature, Shielded Cable			
Weight	150g(Without cable)	150g(Without cable)		

★ ELECTRICAL PARAMETERS

	LCA331A	LDA331A	DP500
Supply Voltage	9~36V	9~36V	9~36V
Alarm Output Current	1000mA	500mA	/
Working Current	40mA	40mA	40mA
Operating Temperature	-40~+85°C	-40~+75°C	-40~+75°C
Storage Temperature	-55~+125°C	-55~+85°C	-55~+85°C

★ APPLICATION RANGE

- Oil Drilling Equipment
- Shield Jacking Application
- Railway Locomotive Monitoring
- Radar Vehicle Platform Detection
- Underground Rig Attitude Navigation
- Geological Equipment Tilt Monitoring
- Ship Navigation Attitude Measurement
- Various Construction Machinery Vehicles
- Angle Measurement Based On Inclination
- Artillery Barrel Initial Firing Angle Measurement
- Satellite Communication Vehicle Attitude Detection
- Various Engineering Machinery Inclination Measurement





## DIGITAL DISPLAY INCLINOMETER



### ★ DMI900

The DMI900 is a level developed by RION based on a high-precision tilt measurement platform that uses quartz pendulum to sense the Earth's gravity component to solve for the object's horizontal tilt angle. The built-in 32-bit microprocessor is combined with a 32-bit high-precision module converter to perform high-subdivision sampling of the weak current-to-tilt ratio signal at the front end, enabling the level to achieve a maximum accuracy of 0.001 degrees and a resolution of 0.0002 degrees.

The product has a built-in large-capacity rechargeable battery with a continuous working time of up to 12 hours.

The product also integrates a USB serial interface, which can transmit the current measurement results to the peripheral port in real time. It can also read the measurement data stored in the level, and can perform live data playback and chart analysis. It is the best instrument for leveling and measuring high-precision platforms.

### ★ FEATURE

- ☆ Best Accuracy: <math><0.001^\circ</math>
- ☆ maximum Measurement Range:  $\pm 45^\circ$
- ☆ Absolute / Relative Measurement Can Be Switched
- ☆ automatic Angle Interpolation Compensation Function
- ☆ Can Set The Alarm Angle



### ★ DMI810/DMI820

DMI820 is a digital inclinometer designed and controlled for various industrial field angles. The core of this product is micro-mechanical control principle, dual-core measuring unit.

The X-axis can be compensated by the Y-axis during the measurement process. The RION patent-interleave and temperature compensation model algorithm is used to give full play to the absolute operational advantages of the micro-mechanical principle, ensuring long-term stability and renaturation of the instrument measurement.

DMI820 is a dual-axis 30° measurement with a resolution of 0.001°, a small range with the highest precision <math><0.003</math> degrees full scale, fast response, and stable data.

The product is specially designed to be mounted on the side and below with strong magnetic adsorption. Both sides of the standard can be measured and used, which brings great convenience to customers.

The DMI820 can be matched with the SM820 and used with our HCA series tilt sensor. The transmission mode can be wireless or wired.

Wireless uses single-pair single-band transmission, transmission linear distance >10m, wired transmission standard 1m (customizable long distance)

The DMI820 series features data storage, three measurement modes (radian, angle, mm), powerful expandability, convenient practical application, industrial reliability, and absolute price/performance advantages. Absolute competitive advantage!

- ☆ Best Accuracy: <math><0.005^\circ</math>
- ☆ Absolute / Relative Measurement Can Be Switched
- ☆ automatic Angle Interpolation Compensation Function
- ☆ customer Can Calibrate Zero
- ☆ Can Set The Alarm Angle
- ☆ Angle / Length Double Unit Switching



### ★ DMI410/DMI420

DMI420 is a digital inclinometer developed by RION for three years. It is based on micro-mechanical control principle and dual-core measuring unit.

In the measurement process, the X-axis can be compensated by the Y-axis, and the RION patent-interleave and temperature compensation model algorithm is used to take advantage of the absolute operation of the micro-mechanical principle to ensure long-term stability and repeatability of the instrument measurement.

The DMI420 is a two-axis 360-degree measurement with a resolution of 0.01°, an accuracy of <math><0.05</math> degrees, a fast response, and stable data.

The special design of the product is designed with strong magnetic adsorption on the side and the bottom. Both sides of the standard can be measured and used normally, which brings great convenience to customers.

The DMI420 can be matched with the SM420 display and used with our LCA series tilt sensor. The transmission mode is wireless or wired.

The wireless adopts single-pair single-wave transmission, and the transmission line distance is > 10 m, and the line transmission standard is 1 meter (customizable long distance)

DMI420 series products have strong scalability, convenient practical application, industrial reliability, and absolute cost performance advantages, and have absolute competitive advantages in the international market!

- ☆ Best Accuracy: <math><0.05^\circ</math>
- ☆ Fast Response
- ☆ Double Reference Magnetic Installation
- ☆ automatic Angle Interpolation Compensation Function
- ☆ Automatic Temperature Drift Compensation
- ☆ customer Can Calibrate Function

### ★ ORDERING INFORMATION

\*Please refer to the product specification for the specific order model.

DMI900	Standard Single-axis Digital Inclinometer Range $\pm 5^\circ/\pm 30^\circ/\pm 60^\circ$ (usb Interface)
DMI810/820	Standard Single And Dual Axis Digital Inclinometer Range $\pm 15^\circ/\pm 30^\circ$
DMI410/420	Standard Single-axis Digital Inclinometer Range $\pm 180^\circ$ Dual-axis Digital Inclinometer Range $\pm 90^\circ$

(Eg: DMI900- $\pm 5^\circ$  means DMI900 single axis,  $\pm 5^\circ$  measurement range)

### ★ DIMENSIONS

UNIT:mm

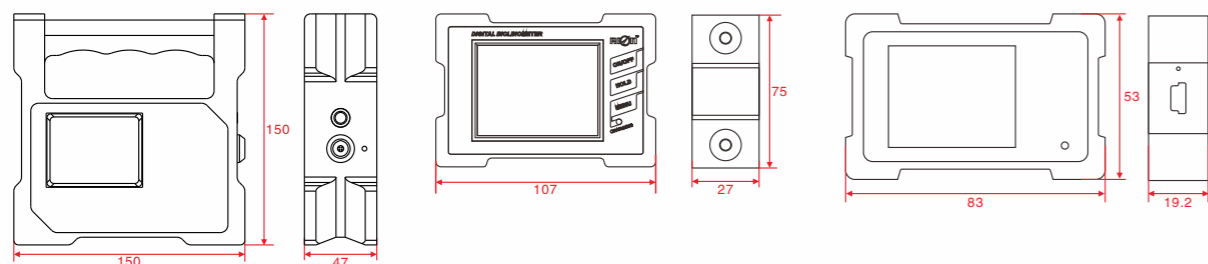

### ★ PERFORMANCE

	DMI900	DMI820		DMI420
Angle Measurement Range	$\pm 45^\circ$	DMI820: $\pm 15^\circ$	DMI820: $\pm 30^\circ$	$\pm 90^\circ$
Millimeter Measurement Range	/	267mm	577mm	$\pm 999.9\text{mm}$
Measuring Axis	Single Axis	Daul Axis		Daul Axis
Highest Measurement Accuracy(rms)	<math><0.001^\circ</math> (Full range)	<math><0.005^\circ</math> ( $\pm 5^\circ$ )	0.01° (Full range)	0.05° ( horizontal position ) 0.1° (Full range)
Measurement Resolution	0.0002°	0.001°	0.001°	0.01°
Millimeter Measurement Accuracy(rms)	/	0.1mm	0.2mm	0.17mm
Millimeter Measurement Resolution	/	0.02mm		0.1mm
Operating Temperature	$-10^\circ\sim+70^\circ\text{C}$			
Working Humidity	85%RH			
Data Output Signal	USB1.1 (Virtual serial device)	USB1.1 (Virtual serial device)	Standard 5Pin USB connector	
Ideal Charging Time	5h	5h	3h	
Battery Continuous Working Time	12h	11h	10h	
Lcd Viewable Area Size	L57.6*W43.2mm	L57.6*W43.2mm		L40*W32mm
Lcd	64 color true color luminous display			
Power Supply	3.7V rechargeable lithium battery			
3 Measurement Modes Selectable	Three modes can be set: radian, degree, mm / meter			
Pc Software	VC application software			
Connector	Standard USB connector, rechargeable function			
Anti-vibration	10g @ 11ms, triaxial and same (half sine wave)			
Impact Resistance	10grms、10~100Hz			
Texture	Anodized aluminum alloy			
Waterproof Level	IP54			
Weight	1200g	275g	120g	
Dimension	L150*W150*H47mm	L107*W75*H27mm		L83*W53*H19.2mm

### ★ APPLICATION RANGE

Building Construction Measurement	Horizontal Calibration	Pipe Installing	Ptz Angle Detection
Production Fixture	Mechanical Installation	Hsr Regulation	Turntable Detection
	Medical Equipment	Precision Instrument Testing	Radar Leveling Platform





★ DMI610

DMI610 is a digital inclinometer designed for various industrial field angle control and measurement. The core of this product is micro-mechanical control principle.

Using the RION patent-interleaving and temperature compensation model algorithm, the absolute operation advantage of the micromechanical and electronic principle is utilized to ensure the long-term stability and repeatability of the instrument measurement.

DMI610 single axis maximum range up to  $\pm 90^\circ$ , resolution 0.002°, highest precision  $<0.02^\circ$  full scale, fast response, stable data.

The product is specially designed to be mounted on the side and below with strong magnetic adsorption. The three-sided reference can be measured and used, which brings great convenience to customers.

The DMI610 series features data storage, three measurement modes (radian, angle, mm/m), powerful expandability, ease of practical application, industrial reliability, and absolute price/performance advantages.

There is an absolute competitive advantage in the international market!

★ FEATURE

- ☆ With Data Storage Function
- ☆ Automatic Angle Interpolation Compensation Function
- ☆ Customer Can Calibrate Zero
- ☆ Three-sided Reference Magnetic Installation
- ☆ Night Vision Four Color Screen

★ DIMENSIONS

UNIT:mm

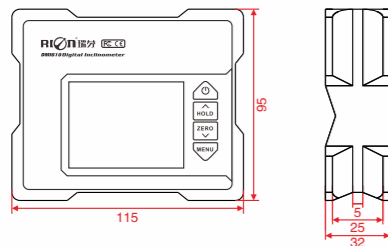

★ APPLICATION RANGE

- Medical Equipment
- Industrial Machinery
- Car Four Wheel Alignment
- Ptz Angle Detection



★ PERFORMANCE

Angle Measurement Range	Single axis $\pm 90^\circ$   Dual axis $\pm 30^\circ$
Measuring Axis	Single and double shaft two in one
Highest Measurement Accuracy(rms)	$< 0.02^\circ$ ( Fullscale )   $< 0.005^\circ$ ( Fullscale )
Measurement Resolution	0.001°
Repeatability	0.004°
Three Measurement Modes Are Available	Radians, Degrees, Mm / M Three Modes Are Optional
LCD	64 Color True Color Luminous Display
LCD Visible Area Size	L60.5*W45mm
Operating Temperature	-10°C ~ +70°C
Working Humidity	85%RH
Power Supply	1.5V
Battery Continuous Working Time	6h
Anti-vibration	10g@11ms, three-axis and same (half sine wave)
Impact Resistance	10grms、10 ~ 100Hz
Weight	600g
Waterproof Level	IP65
Material	Wear-resistant aluminum alloy
Dimension	L115*W95*H32mm

★ ORDERING INFORMATION

DMI610	Standard Single-axis Digital Inclinometer Range $\pm 90^\circ$ Dual-axis Digital Inclinometer Range $\pm 30^\circ$
--------	---

(Eg. : DMI610- $\pm 90^\circ$  means DMI610 single axis,  $\pm 90^\circ$  measurement range)

★ DAM1000

DAM1000 is a remote monitoring display developed by RION for RION brand tilt sensor. The display has powerful functions. It can be used with cable and tilt sensor, or with wireless transmission to use with tilt sensor.

The display accepts any OEM extended design requirements.

The power supply can be powered by an external AC/DC power supply, or it can be powered by an internal large-capacity rechargeable battery. The internal integrated high-precision digital acquisition circuit can collect various numbers: voltage, current, and digital. It can also be extended to connect various industrial terminal control sensor signals, coupled with the support of our professional software and hardware R&D team, to help customers create professional and comprehensive on-site control solutions.

★ PERFORMANCE

Resolution	Depending on the sensor
Wireless Transmission	Working ISM band mode
Wide Temperature Work	-25 ~ +70°C
Storage Temperature	-40 ~ +85°C
Display	Industrial grade colorful display
Screen Visible Area Size	110mm*87mm
Installation Method	Embedded installation
Connector	Connection with waterproof aviation plug
Metal Shell	Brushed alumina
Protection Class	IP54
Outer Box Configuration	Professional portable toolbox
Weight	500g/700g
Dimension	L186*W126*(H30/45mmOptional)

★ APPLICATION RANGE

- Industrial Field Remote Control
- Nuclear Power Plant Remote Control
- Steelmaking Furnace Remote Control



★ FEATURE

- ☆ Industrial Grade Colorful Display
- ☆ A Variety Of Power Supply Options
- ☆ Wireless Transmission: Using The Working Ism Band Mode
- ☆ Can Set Relative Zero Function
- ☆ Can Set The Offset
- ☆ Accept Any Oem Order Service

★ DIMENSION

UNIT:mm

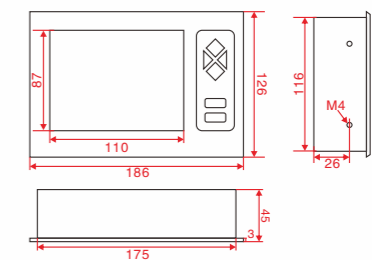

★ MEASURING PRINCIPLE

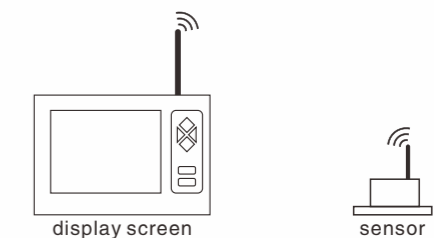





★ SUN-C100

The SUN-C100 dual-axis sun tracking controller consists of a tracking system and sensors. On sunny days, it is controlled by light, and on cloudy days, it uses time data to support control.

With overload protection, short circuit protection, wind protection, late reset, manual tracking, remote control, CSP, CPV temperature control, etc., it automatically turns to the vertical position when it rains or snows.

It is a professional two-axis sun tracking system structure. Our specially designed SUN-C100 sun tracking controller can meet a variety of heat collector applications, including efficient collection of sunlight, high precision, stable and reliable operation.

Available according to user needs and supported solutions!

★ SUN100

The SUN100 2-in-1 solar angle tracking sensor integrates a MEMS tilt sensor and a light intensity sensor.

As we all know, the MEMS tilt sensor has a large measuring range, but the full temperature precision is low, the light intensity sensor has high precision, but the tracking efficiency is low in a large angle range, and the cloudy effect is poor. The SUN100 is compatible with two kinds of sensors, and the sensor simultaneously outputs two signals. For the controller, the controller first combines the local time control and MEMS tilt sensor to complete the initial position tracking (full temperature: <math><1^\circ</math>), and then through the light intensity sensor signal for accurate light tracking (full temperature:

The sun tracking controller and the sun form a closed-loop system, which finely captures each light, makes the sun bigger, the system is simple, the tracking accuracy is high, and it is not affected by weather, season, and geographical location. It is widely used in solar photovoltaic power generation and solar thermal power generation. And automatic tracking of thermal utilization facilities to provide supporting and system solutions for solar tracking projects.

SUN100 sensor belongs to the real industrial grade product, the performance is reliable and stable, the expansion is good, and the dual signal is simultaneously transmitted. The photosensitive surface of the sensor is on the same plane as the device, close to the glass mirror face up, and is installed on the frame fixing plate through the adjustment plate, and inserted. The upper signal cable adjusts the pitch and azimuth angles respectively (it needs to be adjusted in fine weather) to ensure accurate tracking. It can be applied to trough, butterfly, Fresnel, and concentrating photovoltaic tracking.

★ FEATURE

- ☆ Inclination + Light Sense Dual Mode Control
- ☆ Tracking Range:  $\pm 80^\circ$
- ☆ Highest Tracking Accuracy:  $0.05^\circ$
- ☆ With Limit Switch, Overcurrent Protection
- ☆ Auto/manual Dual Mode, Support Remote Control

- ☆ Inclination + Light Sense Dual Mode Tracking
- ☆ Remote Control
- ☆ Highest Tracking Accuracy:  $0.05^\circ$
- ☆ Protection Level: Ip67
- ☆ Low Power Consumption

★ ORDERING INFORMATION

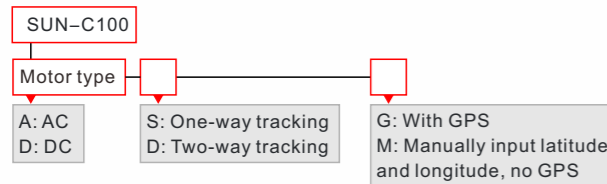

\*Please refer to the product specification for the specific order model.

Example: SUN100 is a fixed selection

★ DIMENSIONS

UNIT:mm

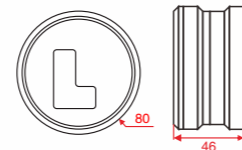
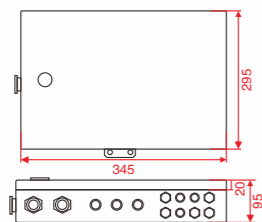

★ PERFORMANCE

	SUN-C100		SUN100
Tracking Angle Range	$\pm 80^\circ$	Angle Measurement Range	$\pm 80^\circ$
Tracking Direction	X Y	Tracking Direction	X Y
Tracking Resolution	$0.01^\circ$	Tracking Resolution	$0.01^\circ$
Inclination Tracking Accuracy(rms)	$0.1^\circ @25^\circ\text{C}$	Angular Accuracy(rms)	$\pm 0.3^\circ @25^\circ\text{C}$
	$\pm 1^\circ @-40\sim+85^\circ\text{C}$		$\pm 1^\circ @-40\sim+85^\circ\text{C}$
Light Tracking Accuracy(rms)	$\pm 0.2^\circ @-40\sim+85^\circ\text{C}$	Light Angle Range	$\pm 0.5^\circ$
Light Measurement Axis	East/Weat/South/North	Light Measurement Axis	X Y
Light Sensitivity Voltage Resolution	$0.1^\circ (0.01\text{V})$	Light Sensitivity Voltage Resolution	$0.01\text{V}$
Light Sensing Voltage Accuracy (rms)	$0.2^\circ (0.05\text{V})$	Light Sensing Voltage Accuracy (rms)	$\pm 0.05\text{V}$
Control Method	DC / AC	Light Angle Resolution	0.1
Drive Current	5A	Light Angle Accuracy(rms)	$\pm 0.2^\circ$
Control The Number Of Motors	4 groups	Output Method	RS485
Protocol	RS485/MODBUS RTU	Protocol	MODBUS RTU
Protection Class	IP65	Protection Class	IP67
MTBF	50000h	MTBF	100000h

★ ELECTRICAL PARAMETERS

	SUN-C100		SUN100
Operating Voltage	9~36VDC	Operating Voltage	24VDC
Working current	20mA@24VDC	Working current	13mA@24VDC
Operating temperature	$-40\sim+85^\circ\text{C}$	Operating temperature	$-40\sim+85^\circ\text{C}$

★ APPLICATION RANGE





★ **DCM250B/DCM260B**

DCM260B is a low-cost 3D electronic compass (with enclosure), using USA patented technology of hard magnetic and soft magnetic calibration algorithm, make the compass eliminate the magnetic influence through calibration algorithm in the magnetic interference environment ,DCM260B integrated three-axis fluxgate sensor, in real time solver heading through the central processor, and using 3-axis accelerometer to proceed heading compensation for the wide range tilt angle, to ensure the compass still can provide high-precision heading data when the tilt angle up to ±85°.Electronic compass integrated high-precision MCU control, various output mode, standard interfaces including RS232/RS485/TTL and other interfaces, and accept other communication interface customization.

DCM260B with small size, low power consumption, can be used for the antenna stability, vehicles, systems integration and other more fields , high shock resistance, high reliability makes the compass work properly in extremely harsh environments, and is more suitable for nowadays miniaturization military high-precision measurement integrated control system.

★ **FEATURE**

- ☆ Azimuth Accuracy: 1°
- ☆ Inclination Resolution: 0.1°
- ☆ Inclination Accuracy: 0.2°
- ☆ Wide Temperature Range: -40°C ~ +85°C

★ **DCM303B/DCM304B**

DCM304B is a high precision 3D electronic compass using the 2D plane calibration algorithm, the calibration no need 3D posture tilt , just flat-situ rotation a circle to complete the calibration process. Using USA patented technology of hard magnetic and soft magnetic calibration algorithm, make the compass eliminate the magnetic influence through calibration algorithm in the magnetic interference environment ,DCM302B integrated three-axis fluxgate sensor, in real time solver heading through the central processor, and using 3-axis accelerometer to proceed heading compensation for the wide range tilt angle, to ensure the compass still can provide high-precision heading data when the tilt angle up to ±85°.Electronic compass integrated high-precision MCU control, various output mode, standard interfaces including RS232/RS485/TTL and other interfaces, and accept other communication interface customization.

DCM304B with small size, low power consumption, can be used for the antenna stability, vehicles, systems integration and other more fields , high shock resistance, high reliability makes the compass work properly in extremely harsh environments, and is more suitable for nowadays miniaturization military high-precision measurement integrated control system.

- ☆ Azimuth Accuracy: 0.5°
- ☆ Inclination Resolution: 0.1°
- ☆ Inclination Accuracy: 0.2°
- ☆ Wide Temperature Range: -40°C ~ +85°C

★ **DCM296B**

DCM296B is a low-cost 3D electronic compass (with enclosure), using USA patented technology of hard magnetic and soft magnetic calibration algorithm, make the compass eliminate the magnetic influence through calibration algorithm in the magnetic interference environment ,DCM296B integrated three-axis fluxgate sensor, in real time solver heading through the central processor, and using 3-axis accelerometer to proceed heading compensation for the wide range tilt angle, to ensure the compass still can provide high-precision heading data when the tilt angle up to ±30°.Electronic compass integrated high-precision MCU control, various output mode, standard interfaces including RS485 and other interfaces, and accept other communication interface customization.

DCM296B with small size, low power consumption, can be used for the antenna stability, vehicles, systems integration and other more fields , high shock resistance, high reliability makes the compass work properly in extremely harsh environments, and is more suitable for nowadays miniaturization military high-precision measurement integrated control system.

- ☆ Best Heading Accuracy: 0.5°
- ☆ Inclination Measurement Range: ±30°
- ☆ Inclination Resolution: 0.001°
- ☆ Inclination Accuracy: 0.01°

★ **ORDERING INFORMATION**

\*Please refer to the product specification for the specific order model.

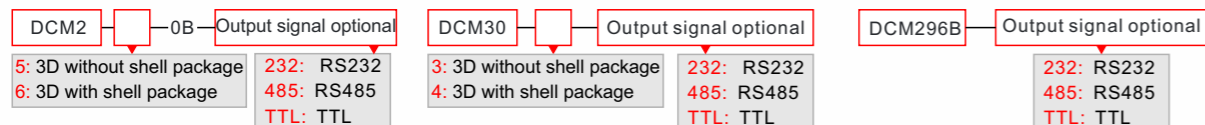

( Eg: DCM205-232: means a single board without a shell package, RS232 digital signal output )

★ **DIMENSIONS**

UNIT:mm

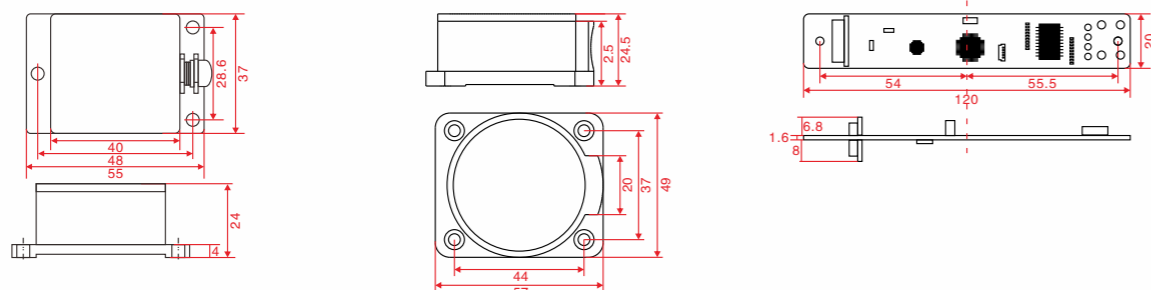

★ **PERFORMANCE**

	DCM260B	DCM304B	DCM296B
Best Heading Accuracy(rms)	≤1°	≤0.5°	≤0.5°
Resolution	0.1°	0.1°	0.1°
Pitch Accuracy(rms)	0.1° ( Small range )	0.1° ( Small range )	0.02°<30° ( Measuring range )
	0.4° ( Full range )	0.4° ( Full range )	\
Pitch Range	±80°	±80°	±30°
Rolling Accuracy(rms)	0.1° ( Small range )	0.1° ( Small range )	0.01°<15° ( Measuring range )
	0.4° ( Full range )	0.4° ( Full range )	\
Roll Tilt Range	±85°	±85°	±30°
Resolution	0.1°	0.1°	0.001°
Magnetic Field Interference Calibration Method	One rotation of the plane (two-dimensional calibration)		
Startup Delay	<50millisecond	<50millisecond	<50millisecond
Maximum Output Rate	20Hz/s	20Hz/s	20Hz/s
Communication Rate	2400 TO 19200baud	2400 TO 19200baud	2400 TO 19200baud
Protective Performance	IP67	IP67	\
Impact Resistance	100g @ 11ms, triaxial and same (half sine wave)		
Anti-vibration	10grms, 10 - 1000Hz		

★ **ELECTRICAL PARAMETERS**

	DCM260B	DCM304B	DCM296B
Supply Voltage	(Default) DC + 5V (Custom) DC 9 ~ 36V	(Default) DC + 5V (Custom) DC 9 ~ 36V	DC+7V DC 9 ~ 36V ( Optional )
Current (max)	45mA	40mA	51mA
Ideal Mode	35mA	30mA	44mA
Operating Range	-40°C~+85°C	-40°C~+85°C	-40°C~+85°C
Storage Temperature	-40°C~+100°C	-40°C~+100°C	-40°C~+85°C

★ **APPLICATION RANGE**

- |                 |                      |                         |                                 |
|-----------------|----------------------|-------------------------|---------------------------------|
| UAV             | Satellite search     | Antenna servo control   | GPS Integrated Navigation       |
| Map painter     | Laser rangefinder    | Artillery launch system | Nautical navigation mapping     |
| Infrared imager | Oceanographic Tester | Special occasion robot  | ROV underwater robot navigation |







★ **HCM370B/HCM375B**

HCM370B-HCM375B is a high accuracy 3D digital compass of strip shape, its width is only 1.95cm, IP67 protection grade, suitable for many harsh environment such as drilling measurement. it adopts advanced hard iron and soft iron calibration algorithm, it can provide the high precision heading value output when both pitch and roll angle at any angle within 360°. it is small and low power consumption, suitable for current miniaturization sensitive measurement system. Sealed complete item and signal board are available.

HCM370B-HCM375B integrated patented three-axis flux-gate technology. It calculates heading value in real-time by CUP, and perform heading value compensation in wide tilt range by using three axis accelerometer. It is high performance and excellent stability militarily level compass sensor. Its volume is small, power consumption is low. It could widely used in many application such as antenna installation, vehicle and integrated system, and so on.

★ **FEATURE**

- ☆ Azimuth accuracy: 0.5°
- ☆ Rolling angle measurement range: ±90°
- ☆ inclination resolution: 0.1°
- ☆ Dip accuracy: <0.2° (full scale)
- ☆ Wide temperature range: -40°C~+85°C
- ☆ With hard magnetic, soft magnetic and tilt compensation

★ **HCM600B/HCM605B**

HCM605B is a dynamic anti-magnetic interference three-dimensional compass instrument, which integrates a 9-axis inertial unit and can measure the magnetic north direction information of the carrier in real time. By judging the abnormal magnetic field interference of the current three-axis magnetic field information, the data fusion algorithm can be performed on the magnetic orientation information and the gyro position information, so that the product can be applied freely in some environments with magnetic field interference.

The product achieves IP67 waterproof rating and is more suitable for drilling measurement. It uses advanced hard iron and soft iron calibration algorithms to provide high-precision heading information on any tool face with a roll angle of ±180°.

With its small size and low power consumption, it is more suitable for today's miniaturized sensitive measurement systems. The product can be ordered with a complete package or circuit board.

- ☆ Azimuth accuracy: 0.3°
- ☆ Rolling angle measurement range: ±180°
- ☆ tilt resolution: 0.05°
- ☆ Dip accuracy: <0.1° (full scale)
- ☆ Wide temperature range: -40°C~+85°C
- ☆ With hard magnetic, soft magnetic and tilt compensation
- ☆ Standard RS232/RS485/TTL output interface

★ **SDC620B**

SDC620B is a new type 3D full-posture compass north finder which launched by our company to the satellite search industry, using USA fluxgate technology and advanced hard iron and soft iron calibration algorithm, to make it still can provide the high accurate heading information in tilt 360° status, still can accurately show the direction angle when tilt 360deg to identify the relative heading position. SDC620B belongs handheld digital instrument and can remote transmit the 3D data to a computer, through RION PC software to proceed with synchronous monitoring and saving data(this function is optional).The products integrated design pitch, roll and heading alarm functions, such as setting the heading angle with 0 degrees alarm point, when products go to 0 degrees position will drive buzzer alarm, humane alert the operator to use. Can also set the magnetic declination and calibrate the magnetic field functions etc. through manual button.

SDC620B display unit using the industrial wide temperature digital blue tube, built-in high-capacity rechargeable battery, the battery life can up to over 10,000 times (when low power with the alarm function), can use 220V pluggable charging, convenient and quick.

- ☆ Hand-held, dovetail installation in one design
- ☆ Angle alarm prompt function
- ☆ with soft and hard magnetic field calibration
- ☆ weak charge reminder function
- ☆ industrial digital tube display, wide temperature, night vision
- ☆ Diversified combination method (optional external 3D compass)

★ **ORDERING INFORMATION**

\*Please refer to the product specification for the specific order model.

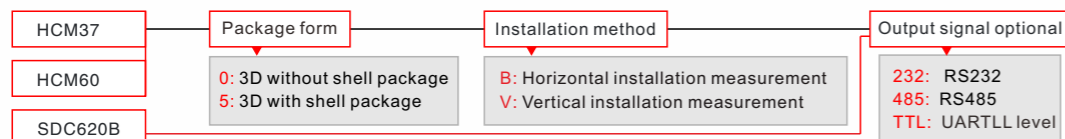

( Eg: HCM375-B-232: means with shell package, horizontal installation measurement, RS232 digital signal output )

★ **DIMENSIONS**

UNIT:mm

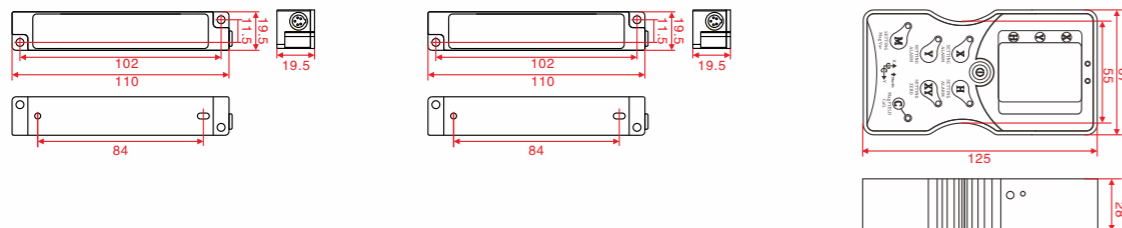

★ **PERFORMANCE**

	HCM375B	HCM605B	SDC620B
Best Heading Accuracy(rms)	0.5°tilt<10°	0.3°tilt<10°	0.5°tilt<10°
Resolution	0.1°	0.1°	0.1°
Pitch Accuracy(rms)	0.1° ( Small range )	0.1°<89° ( Dynamic mode )	0.1° ( Small range )
	0.2° ( Full range )	0.1°<89° ( Static mode )	0.4° ( Full range )
Pitch Range	±90°	±90°	±80°
Rolling Accuracy(rms)	0.1° ( Small range )	0.1°<180° ( Dynamic mode )	0.1° ( Small range )
	0.2° ( Full range )	0.1°<180° ( Static mode )	0.4° ( Full range )
Roll Tilt Range	±180°	±180°	±180°
Resolution	0.1°	0.1°	0.1°
Magnetic Field Interference Calibration Method	One horizontal / vertical turn	One horizontal / vertical turn	3D mining point calibration
RS232/RS485/TTL	5PIN quick plug connector	5PIN quick plug connector	5-pin industrial pluggable connector
Startup Delay	<50millisecond	<50millisecond	<50millisecond
Maximum Output Rate	20Hz/s	20Hz/s	20Hz/s
Communication Rate	2400 TO 19200baud	2400 TO 19200baud	2400 TO 19200baud
Anti-vibration Performance	100g	100g	20g
Protective Performance	IP67	IP67	IP65
Electromagnetic Compatibility	According to EN61000 and GBT17626		
Mtbf	≥40000Hour / time		
Insulation Resistance	≥100Megohm		
Impact Resistance	100g @ 11ms, triaxial and same (half sine wave)		
Anti-vibration	10grms、10 ~ 1000Hz		

★ **ELECTRICAL PARAMETERS**

	HCM375B	HCM605B	SDC620B
Supply Voltage	(Default) DC + 5V	(Default) DC + 5V	External DC + 12V (optional)
Current (max)	37mA	54mA	30mA
Ideal Mode	37mA	54mA	26mA
Operating Range	-40°C ~ +85°C	-40°C ~ +85°C	-20°C ~ +80°C
Storage Temperature	-40°C ~ +100°C	-40°C ~ +100°C	-25°C ~ +80°C

★ **APPLICATION RANGE**

- |                 |                      |                         |                                 |
|-----------------|----------------------|-------------------------|---------------------------------|
| UAV             | Satellite search     | Antenna servo control   | GPS Integrated Navigation       |
| Map painter     | Laser rangefinder    | Artillery launch system | Nautical navigation mapping     |
| Infrared imager | Oceanographic Tester | Special occasion robot  | ROV underwater robot navigation |





★ TG632D Gyro

TG632D is a gyroscope (angle rate sensor) based on the micro mechanical principle, a miniature inertial devices for mainly measuring the angular velocity of a moving object. Product internal with the silicon ultrafine precision ring sensing technology so that it has a high-performance, waterproof, anti-vibration, light weight, anti-electromagnetic interference characteristics and etc. Uninterrupted the machine with self-test technology, the filtering algorithm and the first time in the country by eliminating resonance technology to solve the influence on data because of the surrounding noise or vibration interference source to the ordinary gyroscope. TG632D add another international temperature sensor compensation technology to solve the temperature drift impact problems, with over-temperature stability and long life characteristics etc. to realize the domestic similar products technology-leading technology.

Products with high cost-effective, small volume, more advantages than the FOG in application fields, is now widely used in the automotive, military, marine, moving objects, position control & attitude control, and other applications that require precise angle measurement occasions!

★ FEATURE

- ☆ High performance drift stability
- ☆ low noise, light weight and high cost performance
- ☆ long life and strong stability
- ☆ compact and lightweight design
- ☆ Excellent vibration performance



★ TL740D Angle meter

TL740D is RION company newly developed horizontal azimuth angular gyro sensor based on latest MEMS inertial measurement platform, by means of the dynamic attitude algorithm for the angular velocity of gyroscope, it can simultaneously output carrier's azimuth angle. The product internal integrated RION's Patent Inertial navigation algorithm, through the model of attitude angle data fusion, can solve the gyro short time drift problem as much as possible.

This product is specially used for robot car, AVG vehicle azimuth orientation, attitude control and other related applications of the UAV, instead of the traditional robot vehicle magnetic bar guide shortcomings, no need at the site layout of magnetic stripe, is the necessary navigation components for the next generation of robot vehicle automatic tracing and driving.

- ☆ horizontal azimuth, attitude angle, angular velocity output
- ☆ Advance shaft acceleration
- ☆ Azimuth accuracy: <math><0.1^\circ / 1m</math>
- ☆ Position accuracy: <math><2\text{ mm}/m</math>
- ☆ gyro azimuth static zero drift: <math>1^\circ / h</math>
- ☆ gyro azimuth dynamic zero drift: <math>10^\circ / h</math>



★ TL750D Angle meter

TL750D is RION company newly developed horizontal single axis azimuth angular gyro sensor based on latest MEMS inertial measurement platform, by means of the dynamic attitude algorithm for the angular velocity of gyroscope, it can simultaneously output carrier's azimuth angle, angular rate,

forward axial body acceleration. The product internal integrated RION's Patent Inertial navigation algorithm, through the model of attitude angle data fusion, can solve the gyro short time drift problem as much as possible.

This product is specially used for robot car, AVG vehicle azimuth orientation, attitude control and other related applications of the UAV, instead of the traditional robot vehicle magnetic bar guide shortcomings, no need at the site layout of magnetic stripe, is the necessary navigation components for the next generation of robot vehicle automatic tracing and driving.

- ☆ horizontal azimuth, attitude angle, angular velocity output
- ☆ Advance shaft acceleration
- ☆ Azimuth accuracy: <math><0.05^\circ / 1m</math>
- ☆ Position accuracy: <math><1\text{ mm}/m</math>
- ☆ gyro azimuth static zero drift: <math>0.5^\circ / h</math>
- ☆ gyro azimuth dynamic zero drift: <math>5^\circ / h</math>

★ ORDERING INFORMATION

\*Please refer to the product specification for the specific order model.

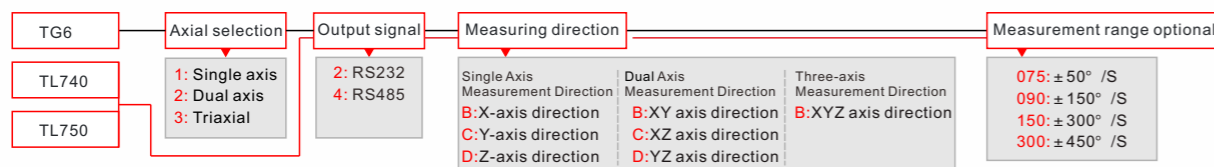

( Eg.: TL632-B-075: means three-axis, RS232 output, XYZ axis direction measurement, 50°/S selection )

★ DIMENSIONS

UNIT:mm

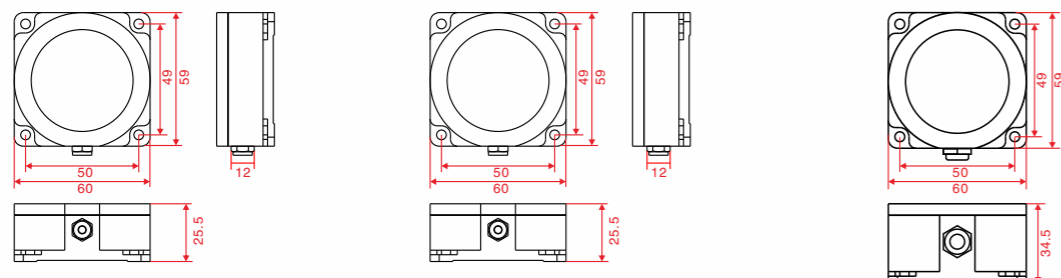

★ PERFORMANCE

	TG632D	TL740D	TL750D
Azimuth Measurement Axial	X、Y、Z ( Optional )	Z-axis azimuth ( ±180 )	Z-axis azimuth ( ±180 )
Acquisition Broadband	100Hz	100Hz	100Hz
Resolution	0.05°/s, 0.1°/s, 0.2°/s	0.01°/s	0.01°/s
Azimuth Accuracy(rms)	/	<math><0.1^\circ / 1m</math>	<math><0.05^\circ / 1m</math>
Position Accuracy(rms)	/	<math><2\text{ mm}/m</math>	<math><1\text{ mm}/m</math>
Gyro Static Zero Drift	/	<math><1^\circ / h</math>	<math><0.5^\circ / h</math>
Gyro Dynamic Zero Drift	/	<math><10^\circ / h</math>	<math><5^\circ / h</math>
Non-linear	0.6%of FS	0.1%of FS	0.1%of FS
Maximum Angular Velocity Bearing	/	$\geq 150g$	$\geq 300g$
Acceleration Range	/	$\pm 3g$	$\pm 3g$
Acceleration Resolution		0.001g	
Acceleration Accuracy		5mg	
Start Time	<math><1\text{ s}</math>	5s(still)	5s(still)
Input Voltage		+9 ~ 36V	
Current		60mA(12V)	
Operating Temperature	-40°C ~ +85°C	-40°C ~ +80°C	-40°C ~ +80°C
Storage Temperature	-55°C ~ +100°C	-40°C ~ +85°C	-40°C ~ +85°C
Output Rate	5Hz/15Hz/35Hz/50Hz	5Hz/15Hz/35Hz/50Hz/100Hz	
Output Signal	RS232/RS485/TLL	RS232/RS485	RS232/RS485
Mtbf		$\geq 50000\text{ Hour / time}$	
Insulation Resistance		$\geq 100\text{ Megohm}$	
Impact Resistance		100g @ 11ms, triaxial and same (half sine wave)	
Anti-vibration		10grms, 10 ~ 1000Hz	
Waterproof Level		IP67	
Weight	152g(Standard wiring)	152g(Standard wiring)	182g(Standard wiring)

★ APPLICATION RANGE

AGV	Equipment	Remote helicopter	Industrial control
GPS	Camera stable	Car safety system	Vehicle mounted satellite antenna equipment
Robot	Platform stable	GPS combination	Electronic magnetic needle error compensation for ships







★ AKF190T/AKF198T

The AKF190T voltage accelerometer is a series of widely used single-axis accelerometers produced by RION's patented Swiss technology. It can be used in vibration testing, impact testing and many other fields.

This series of products features rugged construction, low power consumption and excellent deviation stability, ensuring outstanding output reliability.

The AKF190T is a monocrystalline silicon capacitive sensor consisting of a micromachined silicon chip, a low-power ASIC for signal conditioning, a microprocessor for storing compensation values, and a temperature sensor. This product has low power consumption, is calibrated, has a solid structure and stable output. The new electronic configuration provides solid state power for reset, providing full protection for over-current. The long-term stability and deviation of the scale factor over the full scale range is typically less than 0.1%.

★ AKF192T

The AKF192F single-axis accelerometer is a series of widely used single-axis accelerometers produced by RION's patented Swiss technology. It can be used in vibration testing and impact testing.

The product adopts digital interface output, RS232/485/TTL is optional, different address codes can be set, and multiple sensors are used together in long distance to facilitate multi-point measurement and data analysis.

The AKF192F is a monocrystalline silicon capacitive sensor consisting of a micromachined silicon chip, a low-power ASIC for signal conditioning, a microprocessor for storing compensation values, and a temperature sensor.

This product has low power consumption, is calibrated, has a solid structure and stable output. The new electronic configuration provides solid state power for reset, providing full protection for over-current. The long-term stability and deviation of the scale factor over the full scale range is typically less than 0.1%.

This series of products has the characteristics of strong structure, low power consumption and excellent deviation stability, which guarantees outstanding output reliability.

★ AKF392T

AKF392B three-axis accelerometer is a widely used accelerometers produced by RION's with patented Swiss technology. It can be used in vibration testing, impact testing and other fields. The product adopts digital interface output, RS232/485/TTL, different address codes can be set, and multiple sensors are used together in long distance to facilitate multi-point measurement and data analysis. The AKF392B is a monocrystalline silicon capacitive sensor consisting of a micromachined silicon chip (a low-power ASIC for signal conditioning), a microprocessor for storing compensation values, and a temperature sensor. This product with low power consumption has been calibrated, and has a solid structure and stable output. The new electronic configuration provides solid-state power for reset, providing full protection for over-current. The long-term stability and typical deviation of the scale factor over the full-scale range is less than 0.1%. This series of products has the characteristics of strong structure, low power consumption and excellent deviation stability, which guarantees outstanding output reliability.

★ FEATURE

- ☆ Output signal: 0-5V
- ☆ Power supply voltage: 9-36V
- ☆ Anti-shock: 2000G
- ☆ Storage temperature: -55 °C to +100 °C
- ☆ Working temperature: -40 °C to +85 °C

- ☆ Single axial accelerometer
- ☆ output signal: RS232; RS485; TTL
- ☆ Measurement range is selectable: ±01G/±02G/±04G/±08G/±16G/±32G/±40G
- ☆ Excellent deviation stability, good environmental performance (impact, vibration and temperature)

- ☆ Analog serial port optional
- ☆ Power supply voltage: 9-36V
- ☆ Measurement range optional: ±01G/±02G/±04G/±08G/±16G/±32G/±40G
- ☆ Excellent deviation stability, good environmental performance

★ ORDERING INFORMATION

\*Please refer to the product specification for the specific order model.

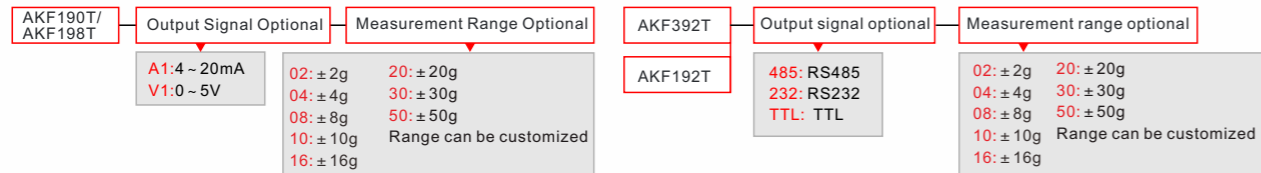

( Eg.: AKF190T-A1-02: means single-axis, Z-axis means measurement, 4-20mA signal output, ±2g selection )

( Eg.: AKF392T-485-02: means three-axis, XYZ-axis means measurement, RS485 signal output, ±2g selection )

★ DIMENSIONS

UNIT:mm

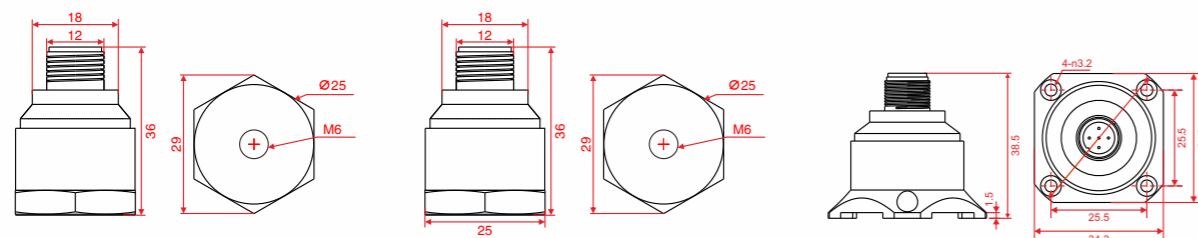

★ PERFORMANCE

	AKF190T/AKF198T			AKF192T			AKF392T		
Range	±2g	±6g	±8g	±2g	±4g	±8g	±2g	±4g	±8g
Zero deviation	±10mg	±20mg	±50mg	±1mg	±2mg	±4mg	±1mg	±1mg	±1mg
Sensitivity coefficient	1.25v/g	0.417v/g	0.1398v/g	Reference Specification			Reference Specification		
	4mA/g	1.333mA/g	0.444mA/g	/			/		
Response frequency	1~1000Hz								
Resonance frequency	5KHz			5.5KHz			5KHz		
Non-linearity	±1%			0.5%			< 3% FS ( Max )		
Repeatability	±25mg	±50mg	±100mg	±5mg	±8mg	±20mg	±5mg	±8mg	±20mg
Start Time	< 0.5s			< 1s			< 1s		
Output port	0-5V 4~20mA			RS485(Modbus RTU) RS232		RS485(Modbus RTU) RS232			
Power consumption	< 5mA@RVDC			< 50mA@RVDC			< 50mA@RVDC		
Protection class	IP67								
Interface accessories	0~≥400								
Impact resistance	100g @ 11ms, triaxial and same (half sine wave)								
Vibration	20g rms,20~2000Hz (Random noise, o, p, i for 30 minutes per axis )								
Weight	60g			60g			73.5g		
Dimension	L29*W25*H36mm			L29*W25*H36mm			L34.3*W34.3*H38.5mm		

★ ELECTRICAL PARAMETERS

	AKF190T/AKF198T	AKF192T	AKF392T
Input Voltage		DC9~36V	
Operating Temperature		-40℃~-85℃	
Storage Temperature		-40℃ ~ +100℃	

★ APPLICATION RANGE

- Engine vibration test
- Bridge vibration monitoring
- Crash Record / Fatigue Monitor Forecast
- Earthquake warning
- Shipborne satellite tracking system
- Low frequency vibration and automatic monitoring
- Traffic system monitoring
- Military and civilian flight simulators
- Subgrade analysis and high-speed railway fault detection



## INTEGRATED-INS



### ★ GP208T

GP208T could provide position, speed, time, heading and pitch angle. It carries on the technology advantage of our company in satellite navigation measurement. By GPS L1, L2, Beidou B1, B3 signals and heading algorithm, it precisely figure out antenna position value and the included angle between two antenna phase position center tie line and true north. When positioning, it could receive differential data link from GPS ground-reference station, realizing carrier phase differential positioning function in real time and improving accuracy to 2cm.

Antenna installation condition: due to the proper work subject to GPS and BD satellite, so the external receiving(sending) antenna not only should be installed in open area without shield and obvious electromagnetic environment, but also be prevented from direct shoot of high power radio transmission equipment, by which damage of antenna even host machine maybe caused.

Salt-mist and water proof: the antenna is installed outside at height by bracket and without shield, so salt-mist and water-proof should be taken good care to protect it. Water-proof tape around connectors and frequent clean should be performed.

### ★ FEATURE

- ☆ Technical advantages in satellite navigation measurement
- ☆ Provide information on the position, speed, time, heading and pitch angle of the carrier
- ☆ Accurately calculate the position information of the antenna and the angle between the two antenna phase center lines and true north
- ☆ Real-time carrier phase differential positioning function
- ☆ Supporting dual antenna positioning and orientation

### ★ INS550D

The INS550D is a MEMS-based integrated navigation system that is fully temperature calibrated on a three-axis turntable to meet performance requirements under different conditions.

Data fusion is realized by a built-in navigation computer. At the same time, the satellite module and digital radio are configured to output real-time accurate carrier attitude, orientation, position, speed and sensor data.

The mobile station is composed of an inertial navigation unit, a quad-band dual-antenna RTK satellite navigation receiver and a digital transmission station.

The satellite navigation receiver calculates the position and azimuth of the carrier through the RTK difference decomposition calculation. The inertial navigation unit gives the attitude angle, angular velocity and acceleration of the carrier, and runs the combined navigation algorithm to obtain the real-time position and orientation data.

- ☆ All-weather/omnidirectional/autonomous rapid positioning under static conditions
- ☆ A short-time inertia calculation for satellite loss the lock
- ☆ Long life, high reliability, strong anti-vibration and impact capability and strong maneuverability (can be started instantaneously, regardless of machine delay)
- ☆ Extensible odometer or altimeter sensor (optional)
- ☆ Integrated high-precision MEMS gyroscope and accelerometer
- ☆ Supporting dual antenna positioning and orientation



### ★ GI3310

GI3310 fiber optic integrated navigation system uses tight coupling technology

Combine the original carrier phase and pseudorange of a high-precision, professional-grade, multi-channel, single/dual-frequency GPS receiver with an inertial measurement unit integrated with a high-precision accelerometer and closed-loop fiber optic gyroscope.

It has the characteristics of small size, light weight and excellent cost performance.

GI3310 can also be combined with odometer navigation, built-in odometer installation difference, scale factor automatic calibration program, user maintenance-free, free to disassemble, can be installed freely on the carrier.

The GI3310 navigation system can provide positioning information such as horizontal attitude and heading, positioning information such as longitude, latitude and altitude, as well as inertial measurement information such as three-dimensional acceleration and angular velocity.

Can be widely used in various fields of land, sea and air to achieve powerful navigation, guidance and control (GN&C)

- ☆ GNSS/INS is tightly integrated
- ☆ Anti-vibration shock and electromagnetic interference
- ☆ Inertia calculation for satellite loss of lock
- ☆ Differential GNSS compatible (optional)
- ☆ GLONASS compatible (optional)
- ☆ Extensible odometer or altimeter sensor (optional)
- ☆ Integrated high-precision fiber optic gyroscope and accelerometer

### ★ ORDERING INFORMATION

Model: GP208T-232  
Description: RS232 output

Model: INS550D-422  
Description: RS422 output

Model: GI3310-422  
Description: RS422 output

\*Please refer to the product specification for the specific order model.

### ★ DIMENSIONS

UNIT:mm

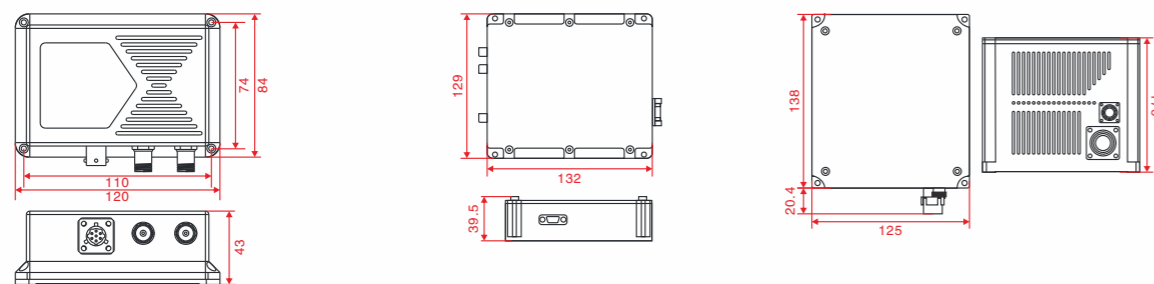

### ★ PERFORMANCE

	GP208T	INS550D	GI3310	
System Indicators	Heading Accuracy	0.2° ,1σ /2m Baseline (Satellite Navigation Mode )	0.1° ,1σ /2m Baseline (Satellite Navigation Mode ) 0.5° ,1σ (External magnetic compass mode )	0.1° ,1σ /2m Baseline (Satellite navigation mode ) 0.3° ,1σ (Self-aligned )
	Heading Resolution	0.01°	0.01°	0.01°
	Attitude Angle Accuracy	0.2° ,1σ ( Pitch ) , No roll	0.2° ,1σ dynamic	0.05° ,1σ dynamic
	Roll&Pitch (1σ)		0.1° ,1σ Static	0.02° ,1σ Static
	Gnss Lost Lock	/	Course 0.5° ,5min	Course 0.5° ,1h
	Initial Alignment Time	10s	10s	10s ( Guardian ) , 3min ( Self-aligned )
	-3db Bandwidth	10Hz	250Hz	300Hz
Gyro Characteristics	Angular Rate Range	/	±250 /s	± 300 /s
	Bias Stability ( 1σ )	/	±20 /h,10s,1σ	± 0.2 /h,10s,1σ
	Biased Repeatability	/	±20 /h	± 0.1 /h
Acceleration Characteristics	Acceleration Range	± 4g	±2g (Other Ranges Can Be Customized )	± 10g
	Bias Stability	/	≤0.2mg	≤ 100ug
	Biased Repeatability	/	≤0.2mg	≤ 100ug
Guardian Characteristics	Gps Frequency	L1, L2	L1, L2, L2C	L1, L2
	Beidou Frequency Point	B1, B2, B3	B1, B2	B1, B2
	Single-point positioning accuracy	2m	1m	1.5m
	Rtk Positioning Accuracy	1cm+1ppm	1cm+1ppm	/
	Timing Accuracy	GPS 50ns/BDS 50ns	GPS 50ns/BDS 50ns	GPS 50ns/BDS 50ns
	Signal Tracking Cold Start	50s	50s	50s
	Signal Tracking Hot Start	15s	30s	≤ 1 s ( Typical recapture )
Environmental Physical Properties	Speed Accuracy	0.2m/s(95%)	0.03m/s	0.1m/s(95%)
	Data Rate	5Hz Default ( 1Hz ~ 10Hz Optional )	5Hz	10Hz
	Supply Voltage	10 ~ 32VDC	12VDC	18 ~ 36VDC
	Power	≤3W	10W ( Mobile station ) 6W ( CORS station )	≤ 12 W @ 24 VDC
	Electrical Interface	RS232	RS422	RS232/422
	Operating Temperature	-40°C ~ +75°C	-40°C ~ +85°C	-40°C ~ +70°C
	Storage Temperature	-45°C ~ +85°C	-55°C ~ +95°C	-50°C ~ +80°C
Vibration	6 g @ 20~2000 Hz	6 g @ 20~2000 Hz	6 g @ 20~2000 Hz	
Shock	30 g, 11 ms, 1/2 Sine	30 g, 11 ms, 1/2 Sine	30 g, 11 ms, 1/2 Sine	
Dimension	L120mm × W84mm × H43mm	L125mm × W95mm × H35mm	L125 × W120 × H101 mm	
Weight	240g ( No Antennas And Cables )	250g(No Antennas And Cables )	2200g	







### ★ AH109B/AH100B

AH100B is a cost-effective AHRS (Micro Attitude Reference System), which can be widely used in AI, UAV, robot and other electromechanical equipment that require high dynamic balance.

The device collects real-time attitude data by collecting sensor data, integrating kalman filtering. Thanks to the three-axis accelerometer and three-axis magnetic sensor-assisted three-axis gyro and temperature compensation algorithm technology, the product achieves excellent stability and real-time performance in full attitude.

It can be applied to various motion attitude monitoring fields, not only to output attitude data, but also to output sensor raw data, physical quantity, quaternion number, etc. by modifying system parameters. At the same time, the system operation cycle can be modified to facilitate various interfaces. The on-chip flash IAP (in application program) technology can be used to maintain the user's parameters according to the user's needs, and can still be remembered after power-off, which is beneficial to the secondary development of the user.

### ★ FEATURE

- ★ Integrated nine-axis sensor and temperature sensor
- ★ Multiple intelligent acceleration and gyro interleave interference algorithm
- ★ Ultra-small size design
- ★ 100Hz update rate
- ★ Real-time 3D dynamic measurement

### ★ GI550

The GI 550 series is a tactical inertial and integrated navigation system built by RION. It is a reliable, high-seismic solid-state inertial measurement unit.

Built-in precision three-axis annular silicon vibrator gyroscope, three-axis oil damping (or air damping) accelerometer, and external compass and GPS, and precision calibration through three-axis turntable to meet the performance requirements under different conditions.

Data fusion is achieved through a built-in navigation computer that outputs real-time accurate carrier attitude, orientation, position, velocity and sensor data.

The GI 550 features an internal shock absorbing structure that maintains performance in strong earthquakes and shocks, and supports external extended GPS for integrated navigation (optional)

- ★ Internal shock absorbing structure, consistent performance under vibration environment
- ★ Accurately calibrate the zero point, zero temperature coefficient, sensitivity, sensitivity temperature coefficient, orthogonality error and acceleration effect of the gyroscope, zero point and zero temperature coefficient of the accelerometer

### ★ IMU560

The IMU560 series is a MEMS combined inertial navigation system developed by RION's independent technology. It is a reliable, high-seismic solid-state inertial measurement unit. Built-in precision three-axis ring-shaped silicon vibrator gyroscope, three-axis oil damping (or air damping) accelerometer and compass, and three-axis turntable precision calibration to meet the performance requirements under different conditions. Data fusion is achieved through a built-in navigation computer that outputs real-time accurate carrier attitude, orientation, position, velocity and sensor data.

- ★ Gyro bias stability 20°/h
- ★ Accelerometer deviation 0.2mg (2g range)
- ★ IMU / VG / GPS / INS mode
- ★ low power consumption
- ★ Car / flight / ship algorithm optional

### ★ ORDERING INFORMATION

\*Please refer to the product specification for the specific order model.

AH109B/AH100B	Output signal optional	232:RS232 422:RS422 485:RS485 TLL:UAR TLL
GI550/GI560	Output signal optional	232:RS232 422:RS422 485:RS485
IMU560	Output signal optional	232:RS232 422:RS422 485:RS485

( Eg.: AH109B-232, means RS232 signal output )

### ★ DIMENSIONS

UNIT:mm

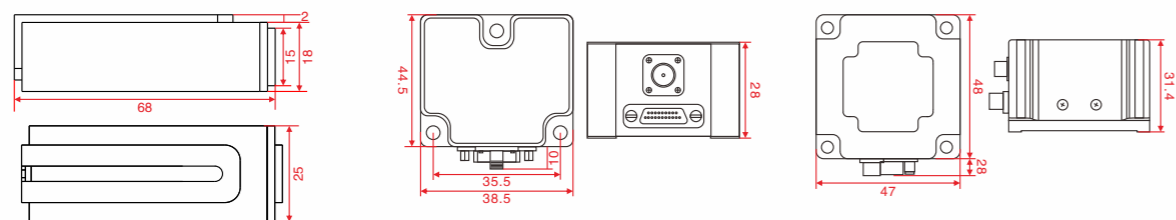

### ★ PERFORMANCE

		AH190B/AH100B	IMU550/GI550	IMU560/GI560	
System accuracy	Course	≤2° , 1σ Compass mode	≤0.3° , 1σ Guardian Mode ≤0.3° /5min Inertial navigation mode	≤0.2° , 1σ Guardian Mode ≤0.2° /5min Inertial navigation mode	
	Horizontal attitude <sup>1</sup> (roll and pitch)	≤2° , 1σ	≤0.2° , 1σ	≤0.1° , 1σ	
	Position <sup>12</sup>	Level	/	2 m, CEP	1.5 m, CEP
		Elevation	/	60m@3min,GPS Lost lock	20m@3min,GPS Lost lock
	Speed <sup>1</sup>	/	≤0.1 m/s, 1σ	≤0.1 m/s, 1σ	
Device main features	Gyro	Range	± 2000° /sec	± 250 deg/s	± 30 deg/s
		Bias stability	<200° /hr	±20/h,10s,1σ	±12/h,10s,1σ
		Biased repeatability	<200° /hr	±20/h,10s,1σ	±12/h,10s,1σ
	Accelerometer	Range	± 2 g/ ± 4 g/ ± 8 g ( Optional )	Default ± 2g, (6g,10g customizable)	Default ± 2g, (4g,8g customizable)
		Bias stability	≤ 10mg	≤0.2mg	≤0.1mg
		Biased repeatability	≤ 10mg	≤0.2mg	≤0.1mg
GNSS	/	B1&B2,L1&L2,SBAS	B1&B2,L1&L2,SBAS		
Data Update Rate ( can Be Set )	100 Hz @ 115,200	100 Hz @ 115,200	100 Hz @ 115,200		
Positioning time	Cold Start	/	≤60 s	≤60 s	
	Typical Recapture	/	≤1 s	≤1 s	
Environmental characteristics	Operating Temperature	-25°C~85°C	-40°C~+85 °C	-40°C~+85 °C	
	Storage Temperature	-40°C~+100°C	-55°C~+125 °C	-55°C~+125 °C	
	Vibration	10grms、 10 ~ 1000Hz	6 g @ 20~2000 Hz	6 g @ 20~2000 Hz	
	Shock	100g@ 11ms , 1/2 Sine	30 g, 11 ms, 1/2 Sine	30 g, 11 ms, 1/2 Sine	
Physical properties	Dimension	L68 × W25 × H20 mm	L45×W39×H28 mm	L47×W48×H31.5 mm	
	Weight	70g	77g	85g	

### ★ ELECTRICAL PARAMETERS

	AH190B/AH100B	GI 550	IMU560
Voltage	5 VDC	5~12 VDC	9~36 VDC
Power Consumption	<26mA @ 5V	<400mA@ 5VDC	<200mA @ 12 VDC
Electrical Interface	TLL/RS232(Optional)	RS232/RS422(Optional)	RS232/RS422(Optional)

### ★ APPLICATION RANGE

- |                         |                              |   |
|-------------------------|------------------------------|---|
| Drone Helicopter        | Ships And Subsea Robots      | Mining And Automatic Farming                          |
| In Motion Attitude Unit | Weapon Targeting System      | Satellite Communication Vehicle                       |
| Mapping Pos System      | Train And Container Tracking | High-speed Train Measurement And Control System       |
| Unmanned Fixed-wing     | Inertial Measurement System  | Vehicle Navigation And Measurement And Control System |





★ MF100

MF100 north finder is a MEMS north finder developed by our company. It is mainly used to quickly determine the true north direction.

After obtaining the azimuth angle, if the north finder inertia begins to move, the dynamic tilt angle and azimuth angle of the change can be continuously output.

The North Finder uses a custom low-rate drift MEMS gyroscope with built-in IMU for inclination measurement and direction estimation. It features micro-miniature, low power consumption, long life and high reliability.

Developed China's first self-developed and mass-produced MEMS north finder. The MEMS north finder is small in size, low in price, and strong in impact resistance. It can replace the high-cost fiber optic gyro north finder, and at the same time, it can replace the scene that the compass cannot be applied because it is not afraid of magnetic interference. The small size is easy to conceal, especially suitable for the orientation of individual combat equipment.

★ FEATURE

- ☆ Low power consumption, 12V, 1A
- ☆ Small size, portable, reliable, IP65 protection
- ☆ Northward accuracy 0.5°
- ☆ Attitude accuracy: 0.1°
- ☆ IMU heading maintenance: 1.5°/15min
- ☆ North seek time: 6min



★ NF600

The NF600 North Finder is a dynamic gyro north finder that consists of a two-degree-of-freedom power-tuned gyro, a two-axis accelerometer, a mechanical rotating device, and a signal solving circuit.

The product consists mainly of a high-precision dynamic tuning gyro and two accelerometers. Utilizing two basic characteristics of a two-degree-of-freedom gyroscope: precession and sizing, The gyroscope rotation axis maintains azimuth with respect to the inertial space, and the earth rotates around the polar axis relative to the inertia space at its rotation angular velocity. If you use the Earth as a reference, you will see the gyroscope's rotation axis rotate relative to the Earth. Therefore, the gyroscope can track and measure the angular velocity of the Earth's rotation. The gyro-sensitive earth rotation angular velocity is different on the X and Y axes, and the orientation information of the product reference axis is obtained. Then, through the two-axis accelerometer, the product's axial inclination data is obtained, and the platform of the product can be adjusted.

- ☆ Power supply: +24~+36Vdc (can be customized)
- ☆ Inclination measurement range: ±8°
- ☆ Attitude measurement accuracy: ±0.06°
- ☆ North seeking accuracy: 0.03°, 0.06°, 0.1°
- ☆ North seek time: 3min
- ☆ Output: RS232/RS422 output
- ☆ Display optional



★ GF800

GF800 is a fiber optic gyro north finder, which is mainly used to quickly determine the true north direction of the carrier.

The internal integrated fiber optic gyroscope and the two-axis orthogonally mounted accelerometer, the mechanical rotating device and the signal solving circuit are formed.

The dynamic tuning gyro has a fixed axis, which can sense the component of the earth's rotation angular velocity in the axial direction of the carrier. The accelerometer can sense the component of the earth's gravity in the axial direction of the carrier, and establish a mathematical model to calculate the azimuth and tilt angle of the carrier.

GF800 series north finder can statically seek north under tilt state, no need to input latitude, small size and easy to use.

According to the conditions of use, it can increase the anti-rain function, and the installation has both formal and flip-chip methods.

Mainly used in fire control aiming, vehicle orientation, radar antenna orientation measurement, etc.

- ☆ Power supply: +24~+36Vdc (can be customized)
- ☆ Inclination measurement range: ±8°
- ☆ Attitude measurement accuracy: ±0.06°
- ☆ North seeking accuracy: 0.03°, 0.06°, 0.1°
- ☆ North seek time: 3min
- ☆ Output: RS232/RS422 output
- ☆ Display optional

★ ORDERING INFORMATION

\*Please refer to the product specification for the specific order model.

MF100	Output signal optional	▶ 485:RS422	(Eg.: MF100-422, representing RS422 signal output)
NF600	Output signal optional	▶ 232:RS232 422:RS422	
GF800	Output signal optional	▶ 232:RS232 422:RS422 485:RS485	

★ DIMENSIONS

UNIT:mm

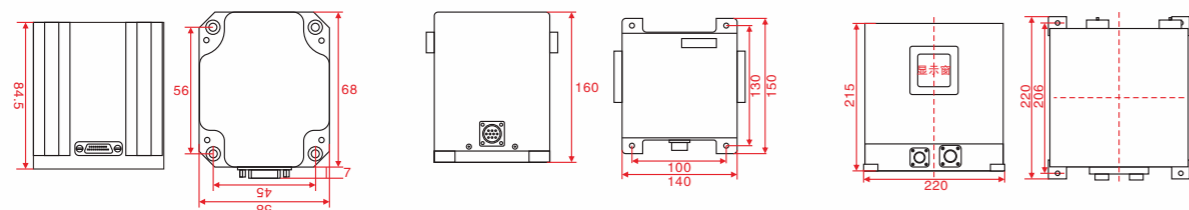

★ PERFORMANCE

	MF100	NF600	GF800
Power Supply	+24Vdc(customizable)	+24 ~ +36Vdc(customizable)	23.2V ~ 30.8V
Working Current	≤1A	<1.5A	<1.2A
Way Of Working	Static	Static	Static
Tilt Measurement Range	90°	±8	±8
Inclination Measurement Accuracy(rms)	±0.1	±0.1	±0.02
Angle Resolution	0.01°	0.01	0.01
Output Method	RS422	RS232	RS232/RS422
Digital Display Of Inclination	0.01 ( Optional )	0.01 ( Optional )	0.01 ( Optional )
Digital Display Of Bearing	0.1 ( Optional )	0.01 ( Optional )	0.01 ( Optional )
Azimuth Measurement Range	0 ~ 360°	0 ~ 360°	0 ~ 360°
North Seek Accuracy ( 1σ )	0.5	0.03/0.06/0.1	0.03/0.06/0.1
Azimuth Resolution	0.1°	0.01°	0.01°
North Seek Time	≤6min	<3min	≤3min
Preparation Time	≤3min	≤3min	≤3min
Weight	<500g	<8kg	≤4kg
Operating Temperature	-40℃~+70℃	-40℃ ~ +60℃	-40℃~+60℃
Save Environment	-50℃~+85℃	-50℃~+85℃	-50℃ ~ +85℃
Impact Resistance	3g, 10ms,1/2 Sine Three directions	3.2g, 10ms,1/2 Sine Vertical direction	30g, 10ms,1/2 Sine Vertical direction
Dimension	L58*W68*H84.5mm	L180*W139*H166mm (customizable)	L220*W220*H215mm (customizable)

Northfinder Measurement Requirements:

- ★ The Flatness Of The Mounting Reference Surface Is ≤0.05mm, And The Product Is Fastened With Screws To Ensure A Rigid Connection;
- ★ Ensure That The Product Axis Is Consistent With The System Test Axis;
- ★ The Environment Must Be Static When Seeking North;

North Seek Accuracy Calculation Method:

$$S = \sqrt{\sum_{i=1}^n \frac{(a_i - a)^2}{n-1}}$$

Formula: s – north Seek Accuracy ( 1σ ) ;

N – number Of Measurements ( n≥8 ) , i=1, 2……n;

αi – the ith time measured value; α – nth times measured mean.

★ APPLICATION RANGE

- Hna Navigation
- Engineering Construction
- Navigation System Initial Value Alignment
- Geodetic Survey
- Equipment Orientation Calibration
- Radar And Antenna Northbound Reference
- Weapon Equipment
- Downhole And Tunnel Measurement
- Military Vehicle North Seeking Equipment







★ **TILT ACQUISITION MONITORING SYSTEM**

The Future Cloud Box is a product compatible with MODBUS protocol data acquisition. It can be transmitted via RS485 and can contain devices that detect battery, temperature and humidity.

The future cloud box can transmit data to the computer and mobile phones stably, and see the status information of the device in real time. Among them, there are three types of WIFI type, GPRS type and TCP type for users to choose.

Software Installation: Scan the following 2D code download, support I S O and ANDROID versions, please select the client.

After registering the account, click "Add Device" in the upper right corner of the APP page to enter

Scan the page, please allow the app to access the camera.



Software download

★ **PERFORMANCE**

Output method	RS-485: Anti-static 2KV
Operating Voltage	DC5~16V
Working current	110mA ( aver ) @5V
Operating temperature	-25~+85℃
Working humidity	-10~+85℃
Save environment	-40~+105℃ 5~95%RH
Power consumption	< 1W
Baud rate	600~230.4K

★ **APPLICATION RANGE**

- |                   |                     |                              |                     |
|-------------------|---------------------|------------------------------|---------------------|
| Bridge Monitoring | Tunnel Monitoring   | Geological Monitoring        | Dam Monitoring      |
| Subway Monitoring | Building Monitoring | Precision Instrument Testing | Turntable Detection |



★ **FEATURE**

- ☆ GPRS type: receiving the joint card to achieve communication (compatible with mobile and Unicom)
- ☆ TCP type: Connect the network cable to realize communication
- ☆ WIFI type: connect to WIFI to achieve communication

★ **DIMENSIONS**

UNIT:mm

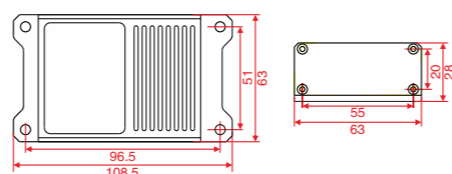

★ **ORDERING INFORMATION**

\*Please refer to the product specification for the specific order model.

Tilt Acquisition Monitoring System

Type selection

- 1: WIFI type (connected to WIFI for communication)
- 2: GPRS type (connected card to achieve communication)
- 3: TCP type (connected to the network to achieve communication)

*Attitude Solution Provider*  
惯性导航专家!