



SPECIFICATIONS

Item No.: DCM260B

Description: High Accuracy 3D Digital Compass(with enclosure)

Production implementation standard reference

- Enterprise quality system standards: ISO9001: 2008 standard (certification number: 128101)
- Tilt sensor production standards: GB / T 191 SJ 20873-2003 inclinometer general specification of Level
- The Academy of metrology and quality inspection Calibrated in accordance to: JJF1119-2004 Electronic Level calibration Specification
- Gyro accelerometer test standard: QJ 2318-92 Gyro accelerometer test methods
- Software development reference standard: GJB 2786A-2009 military software development General requirements
- Product environmental testing standards: GJB150
- Electromagnetic anti-interference test standards: GB / T 17626
- Version|:ver.07

●Revision Date:2014.4.30



General Description

DCM260B is a low-cost 3D electronic compass (with enclosure), using USA patented technology of hard magnetic and soft magnetic calibration algorithm, make the compass eliminate the magnetic influence through calibration algorithm in the magnetic interference environment ,DCM260B integrated three-axis fluxgate sensor, in real time solver heading through the central processor, and using 3-axis accelerometer to proceed heading compensation for the wide range tilt angle, to ensure the compass still can provide high-precision heading data when the tilt angle up to $\pm 85^\circ$. Electronic compass integrated high-precision MCU control, various output mode, standard interfaces including RS232/RS485/TTL and other interfaces, and accept other communication interface customization.

DCM260B with small size, low power consumption, can be used for the antenna stability, vehicles, systems integration and other more fields , high shock resistance, high reliability makes the compass work properly in extremely harsh environments, and is more suitable for nowadays miniaturization military high-precision measurement integrated control system.

Features:

- Heading accuracy: 0.8°
- Tilt angle resolution: 0.1°
- Wide temperature : $-40^\circ\text{C} \sim +85^\circ\text{C}$
- With hard magnetic ,soft magnetic and angle compensation
- Standard RS232/RS485/TTL output interface
- Tilt angle measuring range : $\pm 85^\circ$
- Tilt angle accuracy: 0.2°
- Size: L55×W37×H24mm
- DC 5V power supply
- IP67 protection class

Application :

- Satellite antenna search satellite
 - GPS integrated navigation
- Gun emission system
- Laser range finder
- ROV underwater robot navigation
- Special occasion robot
- Marine navigation surveying and mapping
 - Antenna servo control
 - Infrared imager
 - Map for plotter
- Oceanography measurement instruments
- Unmanned aircraft



Electrical Characteristics

DCM260B Technical Data		
Compass heading parameter	The best heading accuracy	0.8° tilt <10°
		1.5° tilt <30°
		2.0° tilt <40°
		3.0° tilt <70°
	Resolution	0.1°
Compass tilt parameter	Pitch accuracy	0.1°<15° (Measuring range)
		0.2°<30° (Measuring range)
		0.3°<60° (Measuring range)
		0.4°<90° (Measuring range)
	Pitch tilt range	±85°
	Roll accuracy	0.1°<15° (Measuring range)
		0.2°<30° (Measuring range)
		0.3°<60° (Measuring range)
		0.4°<90° (Measuring range)
	Roll tilt range	±85°
Resolution	0.1°	
The best compensation angle range of compass tilt	<40°	
Calibration	Hard iron calibration	Yes
	Soft iron calibration	No
	Magnetic field interference calibration method	Plane rotation in a circle (2D calibration)
Physical features	Dimension	L55×W37×H24mm
	Weight	20g
	RS-232/RS485/TTL interface connector	5cable 1M direct lead line
Interface features	Start delay	<50MS
	Maximum output rate	20Hz/s
	Communication rate	2400 to 19200baud
	Output format	Binary high performance protocol
Power	Power supply	(Default) DC+5V
		(Customized) DC9~36V
	Current(Maximum)	45mA
	Ideal mode	35mA
	Sleep Mode	TBD

Environment	Operating range	-40℃~+85℃
	Storage temperature	-40℃~+100℃
	Resistance shock performance	2500g
Electromagnetic compatibility	According to EN61000 and GBT17626	
MTBF	≥40000 hours/times	
Insulation resistance	≥100M	
Shock resistance	100g@11ms、3Times/Axis(half sinusoid)	
Anti-vibration	10grms、10~1000Hz	
Weight	30g(without cable)	

Ordering information:

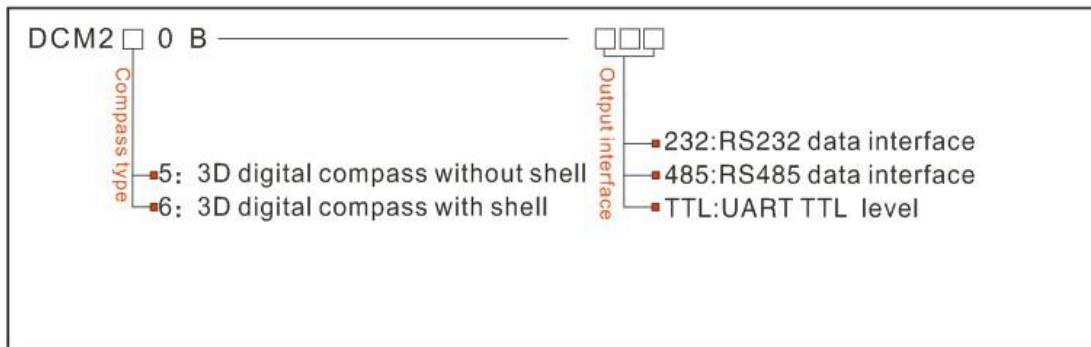

E.g: DCM260B-232: 3D with enclosure sealed/RS232 output

DCM260B Measuring Directions&Fix

The DCM260B 3D electronic compass azimuth is using geomagnetic principle, so it is very important to select a minimum magnetic interference environment for installation position. Please place and install the DCM260B away from the iron, magnets, engines and other magnetic objects as much as possible as you can. Need control over 40CM distance(different magnetic interfere with the compass in different distance) at least even there are these magnetic medium around . In order to ensure optimal measurement environment please must use the **M3 stainless screws for installation** .

Although DCM260B can compensate the moderate deviation in the stable magnetic environment, but it can not compensate the changed magnetic interference. Please pay much attention to the wire with DC will generates a magnetic field , because if the DC change then the magnetic field will also change in size . The battery also is another interference source of changing . Each installation is different, and the user must evaluate the feasibility of installation under all possible operating environment.

The optimal heading accuracy of DCM260B can reach 1 ° , this undergo a rigorous validation indisputable, the most scientific test method is equally crucial. The test method we recommend is: Please install the DCM260B electronic compass to a vertical and erect aluminum pole (non-magnetic material), then proceed with heading accuracy measurement (of course the rotating rod perpendicular to the rotating platform, as much as possible to avoid large external magnetic field interference). Doing so can reduce the compass turning radius, to scientifically improve the measurement accuracy. This is just to provide the installation of the laboratory, must be flexible to deal with the specific situation.E.g: is mounted in the car, DCM260B should do its installation in the perpendicular to the movement direction.

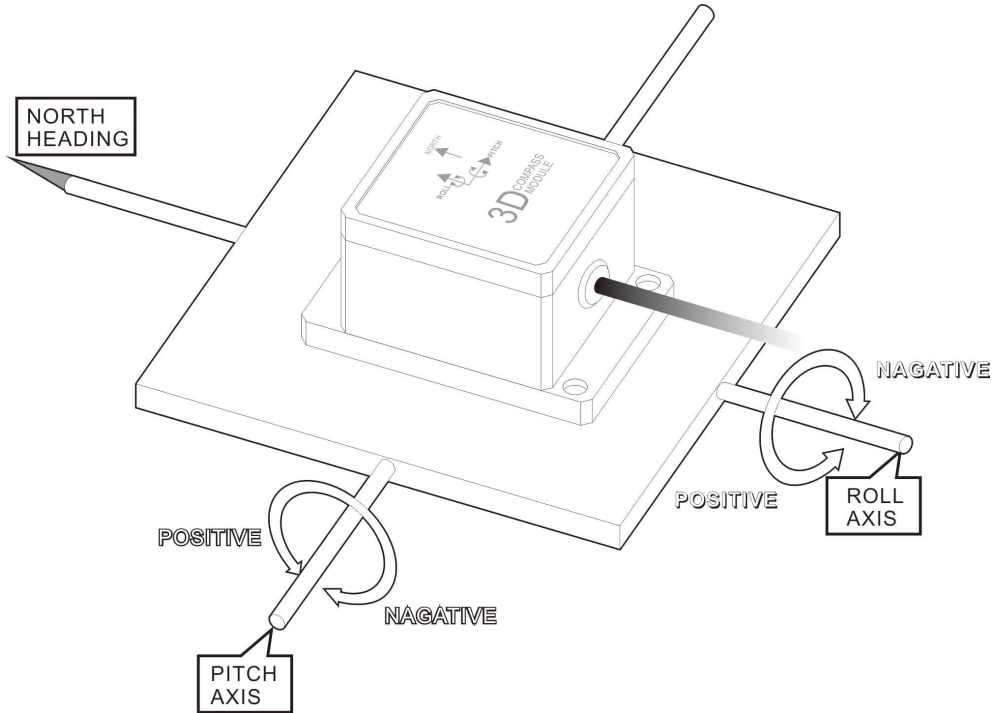

Dimension :

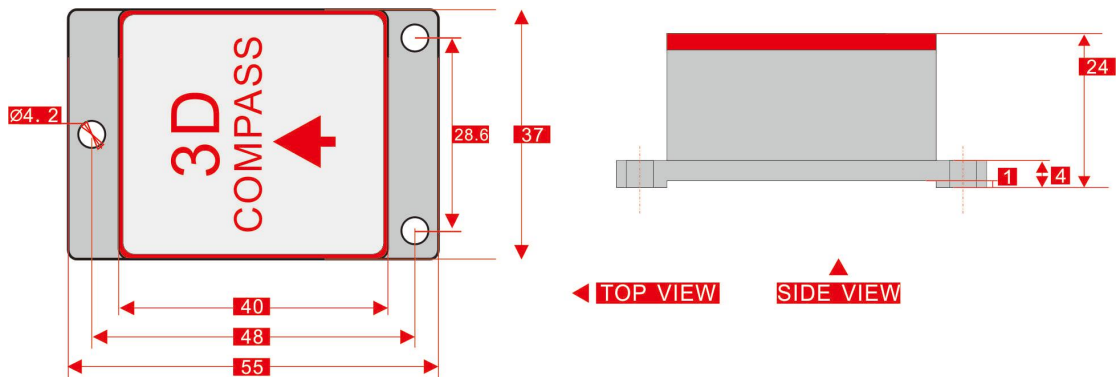

Size:L55*W37*H24

Electrical Connection

Line color	RED	BLACK	YELLOW	GREEN
function	Vcc 5V Power supply positive	GND Power supply negative	RS232(RXD) Or RS485(D+)	RS232(TXD) Or RS485(D-)

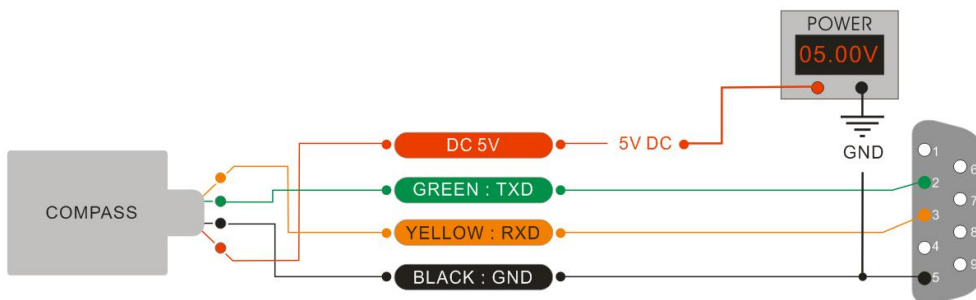

DCM260B Calibration methods:

Calibration lemmas:

1) The accuracy of testing compass can not reach the requirements;
 2) compass installation environment have magnetic interference, the interference is fixed, and the interference magnetic field and compass installation will not happen again in distance changes (example: compass to be installed above an iron material, because the iron will have magnetic interference, at this time then need to rotate and calibrate the iron and compass, and the iron and compass will not be separated when using , once they are separated then need to recalibrate. If the iron size is not fixed, or with a compass distance change is not fixed, the interference can not be calibrated,only can install it in a very far away , safe distance control in above 40cm).

- 1) Please horizontally place the compass to a flat surface away from the interference, and correctly connected to the RS232 communication port, turn on the power.
- 2) Send the calibration start command: 68 04 00 08 0C in hexadecimal format. (Or click the Rion's 3D debugging software "CALI-START" button)
- 3) DCM compass will return the response command.
- 4) Rotate the compass from 0 ° to 360 ° in a circle at original position , then proceed the magnetic field data acquisition surround the compass(rotational speed should not too fast , control more than 40 seconds / turn.)
- 5) After back to 0 °,re-send stop calibration command: 68 04 00 0A 0E in hexadecimal format, calibration success (or click Rion's 3D the debug software "CALI-SAVE" button)

Note: If the compass is fixed install in other devices, the devices have magnetic interference, after compass to be installed, then rotate it with supporting devices together, to collect the interference source of the supporting products , to ensure the compass with a accurate measurement

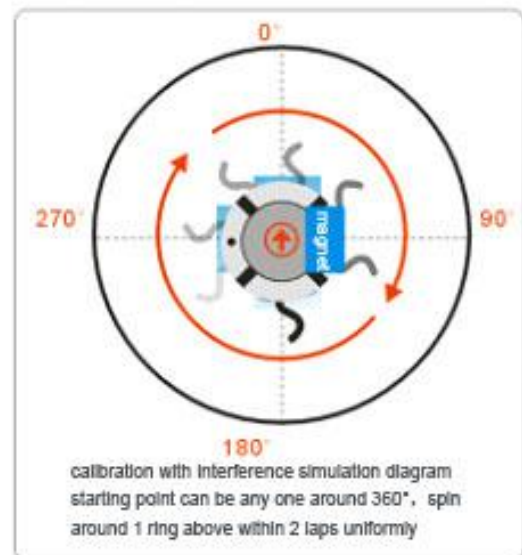
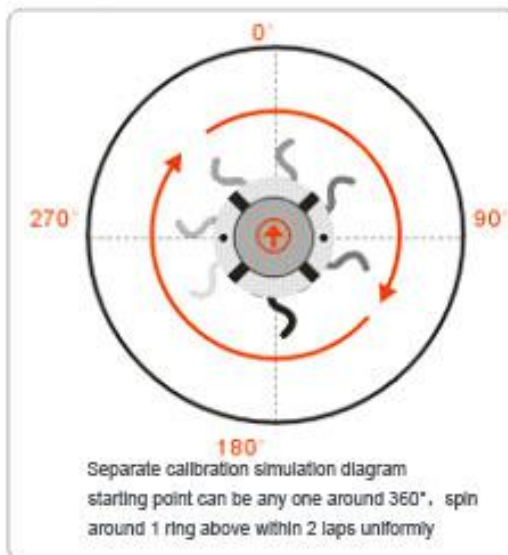

RION's 3D Software

You can download the RION angle debugging software from RION's official website for the preliminary angle debugging, also you Can download public version of the comassistant software on line for using .

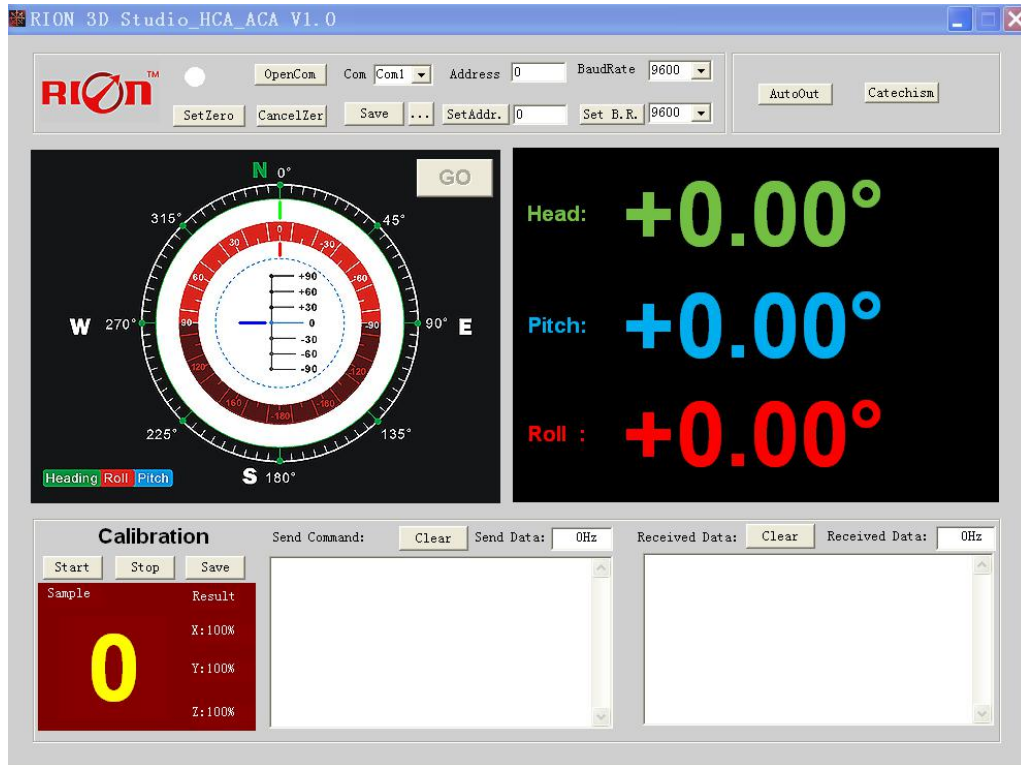

Open/Close: Open and close COM port;

Com: Select the the device corresponding to the COM port

Address: Fill in the sensor current address code, the factory default is 00

Set Address: Set the sensor address code input box on the right to enter the desired address code, click Set Addr button

Save Data: Save the data, click here data can be synchronized Save angle data, the file is stored by default in the C: ---- COMDATA file

Set Zero: Set relative zero, the sensor current angle is 00.00 degrees

Cancel Zero: Unset the relative zero, to restore the sensor to the factory absolute zero;

Baud Rate: Select the sense baud rate , the factory default is 9600;

Set Baud Rate: Set the sensor baud rate, on the right of the selection box to select corresponding baud rate then click SetB.R. button;

Auto Output: Switch the sensor to automatically output mode, in the automatic output mode can be filled with different output frequency in Hz;

Catechism: The sensor switch to answer pattern, such as choosing the answer type, must input "send command "(command, please refer to the specification) on the left of "Send Command" input box, but also can fill in the transmit frequency in the Send Data, the unit Hz;

Mag. Dec.: Magnetic declination setting, in the right box directly enter the local magnetic declination, click "Mag.Dec." Button to confirm .

Calibration: compass calibration forum

Start: Start calibration

Save: stop calibration and save data. (Specific calibration method please refer to this specification calibration description)

Note: after install the RION's debugging software, if can not open, please operate by the following steps (please appear to the administrator status to operate):

- 1) Copy these three files mscomm.srg、mscomm32.ocx、mscomm32.dep from the folder to C:/Windows/system32 path below.
- 2) Click "Start" –"run" --regsvr32 mscomm32.ocx, You are prompted to install successful dialog.

Product Protocol

一、**DATA FRAME FORMAT**: ((8 bits date, 1 bit stop, No check, Default baud rate 9600)

Identifier (1byte)	Date Length (1byte)	Address code (1byte)	Command word (1byte)	Date domain	Check sum (1byte)
68					

Identifier: Fixed68H

Data length: From data length to check sum (including check sum) length

Address code: Accumulating module address, Default :00

Date domain will be changed according to the content and length of command word

Check sum: Data length、Address code、Command word and data domain sum,No carry.

二、COMMAND word analysis

Desc.	Meaning/Example	Description
0X04	Meanwhile read Pitch、 Roll、 Heading Angle command 68 04 00 04 08	Data domain (0byte) No Data domain command
0X84	Sensor answer reply E.g: 68 0D 00 84 00 10 50 10 10 05 01 04 01 22	Data domain (9byte) AA AB BB CC CD DD EE EF FF AA AB BB:3 Characters is Pitch Axis CC CD DD:3 Characters is Roll Axis EE EF FF: 3 Characters is Heading Angle format with same analytic method as Pitch、 Roll、 Heading On the left example , the angle is : Pitch: +010.50°,Roll:-010.05°, Heading+104.01°
0X06	Setting declination command 68 06 00 06 02 08 16	Data domain (2byte) SA AB S is symbol 0 positive 1 negative AA: two digits integer, B: two digits decimals E.g: 02 08 is +20.8 deg
0X86	Sensor answer reply E.g: 68 08 00 86 00 8B	Data domain (1byte) Data domain in the number means the sensor response result 00 Setting successfully FF Setting failure
0X07	Read declination command 68 04 00 07 0b	Data domain (0byte) No Data domain command
0X87	Sensor answer reply E.g: 68 06 00 87 02 08 97	Data do (2byte) Data domain in the number means the sensor response result
0X08	Start calibration command	Data domain (0byte)

	68 04 00 08 0C	No Data domain command
0X88	Sensor answer reply E.g: 68 05 00 88 00 8D	Data domain (1byte) Data domain in the number means the sensor response result 00 Start success FF Start failure
0X0A	Save calibration command 68 04 00 0A 0E	Data domain (0byte) No Data domain command
0X8A	Sensor answer reply command E.g: 68 05 00 8A 00 8F	Data domain (1byte) Data domain in the number means the sensor response result 00 Success FF Failure
0X0B	Setting communication baud rate command 68 05 00 0B 02 12	Data domain (1byte) Baud rate: default :9600 00 means 2400 01 means 4800 02 means 9600 03 means 19200 04 means 38400 05 means 115200
0X8B	Sensor answer reply command E.g: 68 05 00 8B 00 90	Data domain (1byte) Data domain in the number means the sensor response result 00 Success FF Failure
0X0F	Setting module address command 68 05 00 0F 01 15	Data domain (1byte) XX module address, address from 00 to EF range Note: Our products have a unified address: FF, If forgot the set address when operating ,can use the FF address to operate the product, still normal response.
0X8F	Sensor answer reply command E.g: 68 05 00 8F 94	Data domain (1byte) Data domain in the number means the sensor response result 00 Success FF Failure
0X0C	Setting angle output mode 68 05 00 0C 00 11	Data domain (1byte) 00: answer reply mode 01: Auto output mode Default : answer reply mode
0X8C	Sensor answer reply command E.g: 68 05 00 8C 00 91	Data domain (1byte) , Data domain in the number means the sensor response result 00 Success FF Failure



※NO:Please visit our website for more information: www.rion-tech.net
(product functions, parameters and appearance will be adjusted as the technology is upgraded, please confirm with the pre-sales business contact before purchase.)





深圳市瑞芬科技有限公司
CHINA SHENZHEN RION TECHNOLOGY CO.,LTD.

•INCLINOMETER •TILT SWITCH •ACCESSORIES •NORTH FINDER •TURNTABLE
•ELECTRONIC COMPASS •DIGITAL INCLINOMETER •ACCELEROMETER
•ATTITUDE AND HEADING REFERENCE SYSTEM •ELECTRONIC GYROSCOPE

T : (86) 755-29657137

F : (86) 755-29123494

W : www.riontech.cn

E : sales@rion-tech.net

A : Block 1, COFCO(FUAN) Robotics Industrial Park , Da Yang Road 90,
Fuyong Distict, Shenzhen City, China

Attitude Solution Provider
姿态方案解决专家!