

SPECIFICATION

Micronel Tube Fan

D341P-012KM-4



GENERAL INFORMATION

Item

Product type	Tube fan with integrated electronic motor driver
Article no.	D341P-012KM-4 D343P-012KM-4 with flange at outlet (option) D344P-012KM-4 with flange at inlet (option)
Manufacturer	Micronel AG
Customer	N/A
Project no.	N/A
Modification	Standard product

APPLICATION

Tube fan with high airflow, economic motor and integrated power electronic. Compared to a flat fan, the Micronel D-Line offers much higher pressure and still high volume flow at the same time. Typical applications are cooling and suction, where powerful fans are needed.

FEATURES

- Pressure 6.41 hPa, flow rate 484 l/min
- 12 VDC brushless DC-motor
- Speed control and tacho frequency signal
- Small dimensions through slim design
- Options for mounting flange with holes

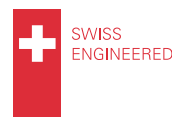

SWISS
ENGINEERED



DECLARATION OF
CONFORMITY
NON-USE OF
CONFLICT MINERALS

GENERAL CONDITIONS

Unless otherwise stated all data are measured at nominal voltage and are valid at 20 °C ambient temperature and 1.2 kg/m³ standard air density. Values listed are nominal and can vary depending on the installation conditions and due to component tolerances. Test setup according to ISO 5801 with standardized inlet and outlet chambers. Tolerances based on specified speed data according to ISO 13348, grade 4: pressure +/-10 %, power +16 %. Tolerances based on constant voltage: speed +/-10 %, pressure +/-21 %, power +33 %. For continuous blower operation please refer to specified maximum ratings. Performance data outside normal operating range plotted for information only.

PERFORMANCE

Pressure Operation at Inlet

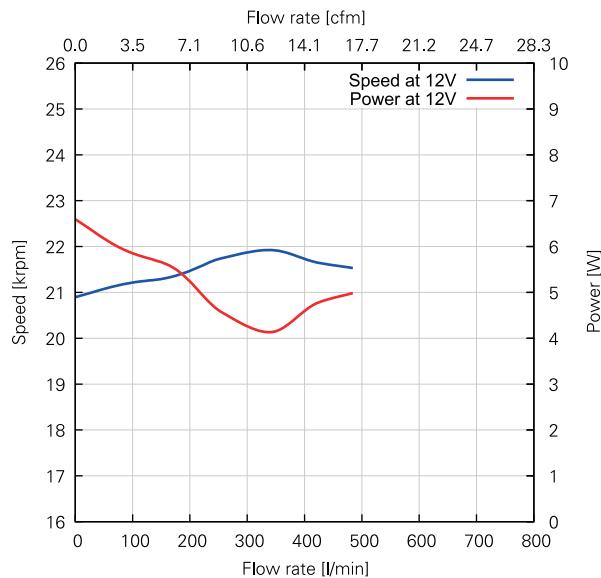
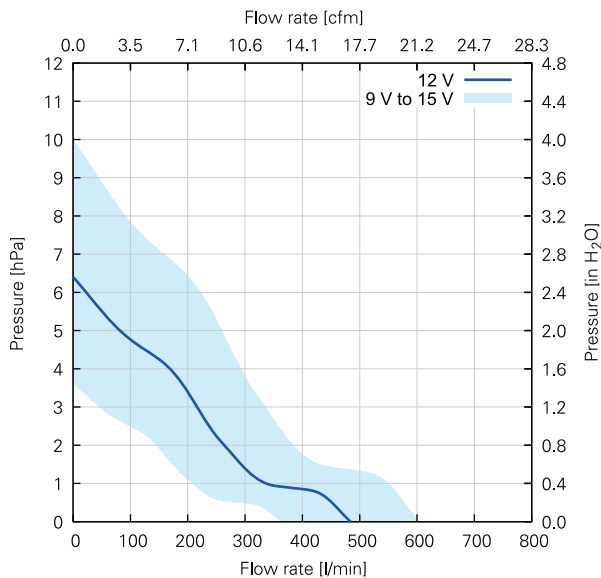

Vacuum Operation at Inlet

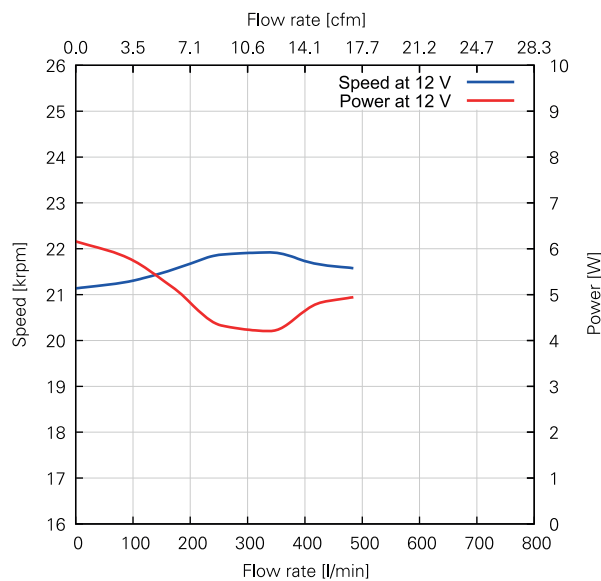
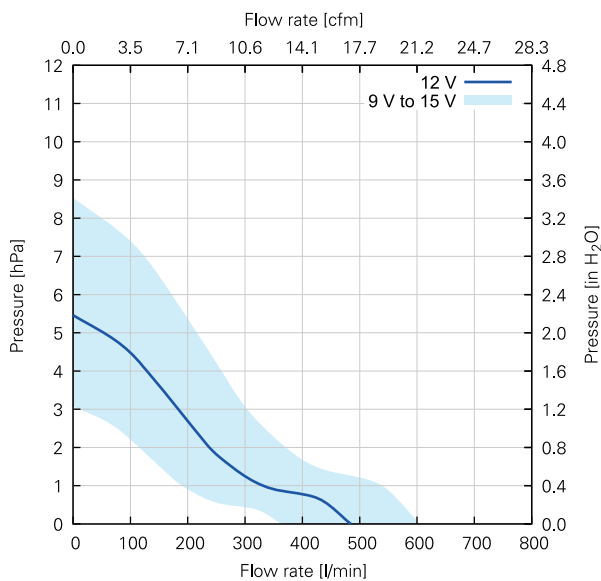

Shut-Off in Pressure Operation (Zero Flow Rate)

	Unit	Value
Static pressure	[hPa]	6.41
Power consumption	[W]	6.53
Speed	[rpm]	20900

Shut-Off in Vacuum Operation (Zero Flow Rate)

Static pressure	[hPa]	5.46
Power consumption	[W]	6.16
Speed	[rpm]	21140

Free-Air (Zero Static Pressure)

Flow rate	[l/min]	484
Power consumption	[W]	4.97
Speed	[rpm]	21550

TECHNICAL DATA

Electrical	Unit	Value
Nominal voltage	[VDC]	12
Voltage range	[VDC]	9 to 15
Minimum power supply current ⁽¹⁾	[A]	N/A
Maximum start-up time	[s]	N/A
Maximum ripple voltage	[%]	5
Maximum Ratings for Continuous Operation		
Minimum flow rate	[l/min]	N/A
Maximum speed	[rpm]	N/A
Maximum acceleration	[rpm/ms]	N/A
Maximum power consumption	[W]	N/A
Maximum housing surface temperature	[°C]	N/A
Maximum NTC temperature	[°C]	N/A
Environmental		
Ambient temperature (operating)	[°C]	-20 to 65
Ambient temperature (storage)	[°C]	-20 to 65
Relative humidity (noncondensing)	[%RH]	10 to 85
Ingress protection (EN60529)		IP40
Maximum oxygen concentration ⁽²⁾	[%]	N/A
Motor		
Type		Brushless direct current motor
Winding insulation class		H, 180 °C
NTC type		N/A
Lifetime		
L10 at 25 °C ambient temperature ⁽³⁾	[h]	20000
Acoustics		
Sound pressure level ⁽⁴⁾	[dB(A)]	60.7
Leak Tightness		
Maximum leak flow rate	[l/min]	N/A
Mechanical		
Blower weight	[g]	43

⁽¹⁾ Recommended minimum continuous power supply current for proper start-up behavior at nominal voltage. This is an indicative value. Power supply dimensioning, wiring, safety, setup and validation is the customer's responsibility.

⁽²⁾ Micronel blowers are designed for various levels of oxygen compatibility. Further information available on request.

⁽³⁾ Accelerated aging test at 45 °C ambient temperature, operation cycle 11.5 h ON, 0.5 h OFF, normal cleanliness according to ISO 281. Temperature dependency of lifetime according to IPC-9591: factor 1.5 per 10 °C.

⁽⁴⁾ Measured at distance of 1 meter from inlet, with open inlet and outlet.

DRAWINGS

Dimensions in mm

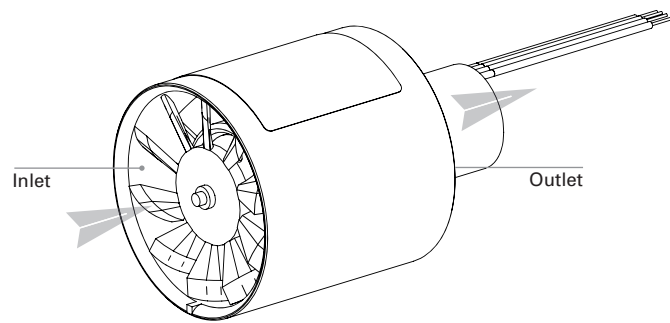
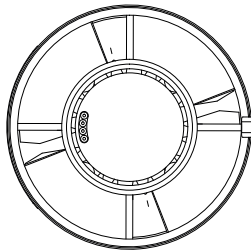
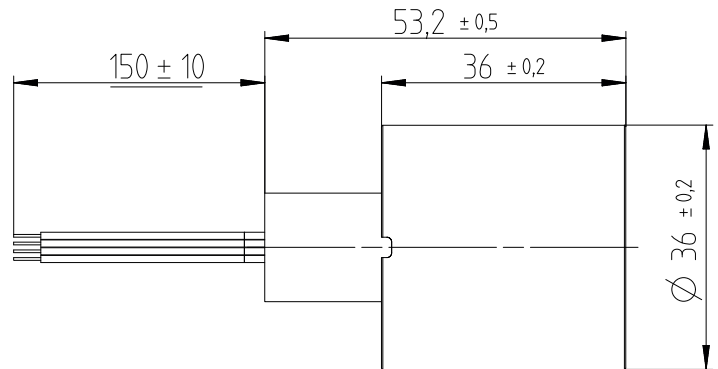
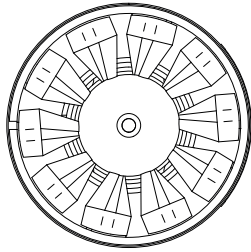
**Orientations**

Direction of rotation

↻ Clockwise (view on inlet)

Mounting position

Any direction

MATERIALS**Components****Material**

Fan housing

Polyphenylenoxide (PPO)
Flammability: UL 94V-1

Impeller

Polyphenylenoxide (PPO)
Flammability: UL 94V-1

Hub

-

Motor housing

-

Label

Plastic

Connector

-

Crimp terminal

-

Lead wire

Silicone insulated cable
Flammability: UL 3239

IDENTIFICATION

Label

Design

Article number: **D341P-012KM-4**

Nominal voltage: **12VDC (9-15VDC)**

Voltage range: **9-15VDC**

Identification number: **2015999999 001**

Identification number details:

- Year, calendar week (YYWW)
- Fabrication number (6 digits)
- Serial number (3 digits)

Pinout legend:

- red: Vcc
- black: GND
- yellow: Tacho
- green: set speed

BLOWER PINOUT

Pin	Color	Description	AWG
1	Red	V _{CC}	28
2	Black	GND	28
3	Yellow	Tachometer output	28
4	Green	Set speed input	28

ELECTRONIC FUNCTIONS

Integrated Electronic Motor Driver

Type	Brushless direct current motor driver
Features	<ul style="list-style-type: none"> • Integrated speed control (PWM) • Tachometer frequency signal • Locked rotor protection • Over current protection

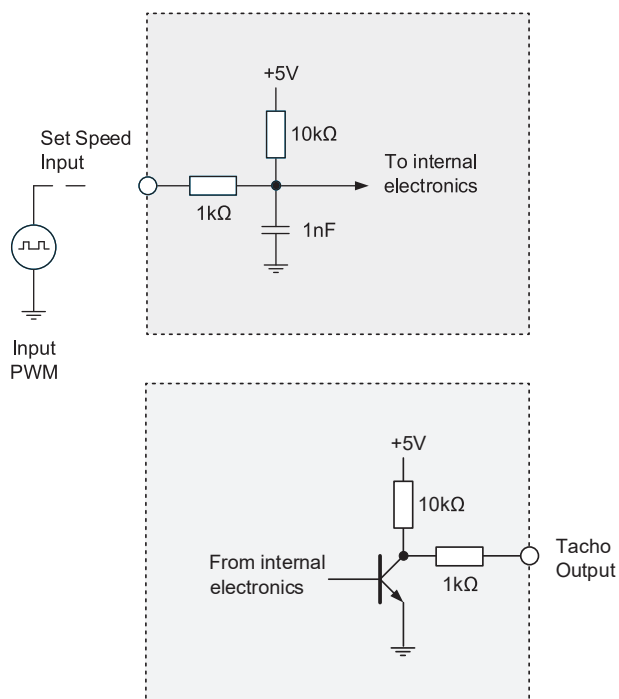

Speed Control Input

The blower speed can be controlled by PWM. See „Set Speed Input“ table for further details.

Tachometer Output

Tachometer frequency:
1 pulse per revolution

n = 60 · f

n Rotation speed [rpm]
f Tacho frequency [Hz]

ELECTRONIC FUNCTIONS

Set Speed Input PWM [%]	Operation Mode
Set speed not connected	Fan speed at 100 %
0.0	Stop
0.2 to 5.0	Not defined, fan might run or stop
6.0	Minimum start-up
6.0 to 100.0 (after start-up)	Fan speed dependent on duty cycle

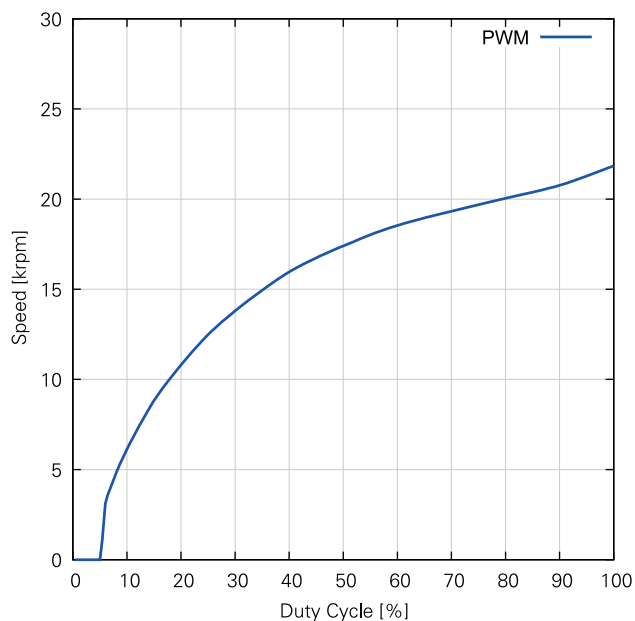



Frequency 1 kHz – 60 kHz; (TYP 10 kHz)

OPTIONS FOR MOUNTING

Product no. with options	Flange Inlet	Flange Outlet
Micronel Tube Fan D341P-012KM-4		
Micronel Tube Fan D343P-012KM-4*		●
Micronel Tube Fan D344P-012KM-4*	●	

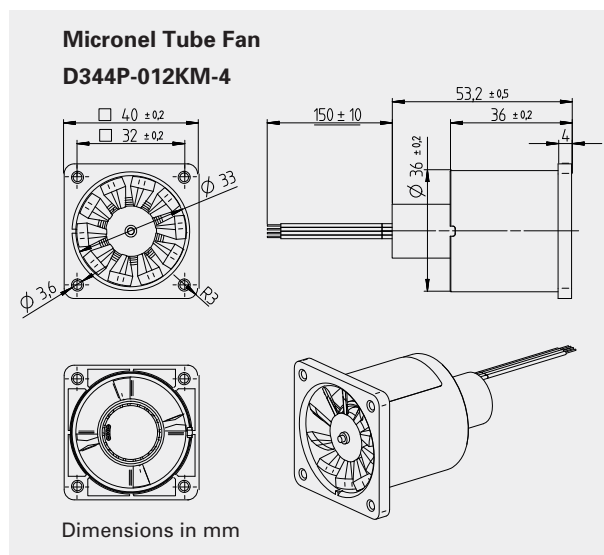
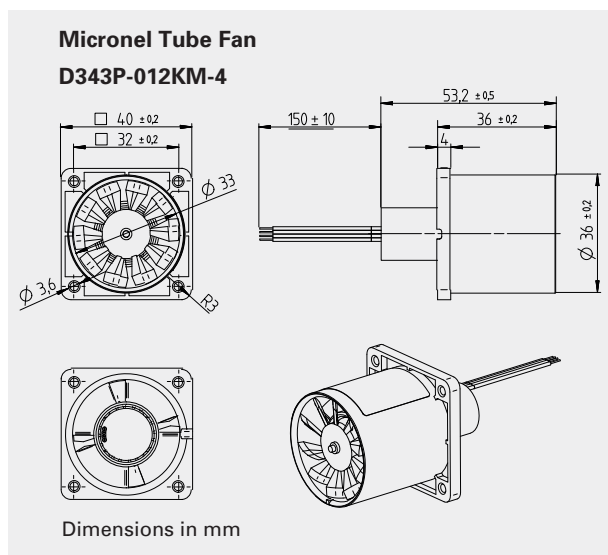
* The drawings show versions of flange.



 Handle in power-off conditions only!
Read operating manual!

All data are subject to change without advanced notice.
© 2021 by Micronel AG. All rights reserved.